

Original design cordless lighting +



Now it's time to change old lighting
to cordless lighting

Use cordless lighting anywhere you want.





40 years

Production experience

30

Business cooperation

ODM/OEM

Custom order

- A leading manufacturer of rechargeable LED lamps; solar LED lamps and outdoor LED lamps in the world.
- A OEM / ODM manufacturer of many well-known top brands in Europe. Original design by European designers.
- A reliable partner offers all the supports which you really need, help expanding your lighting / furniture / HoReCa business constantly.

ODM & OEM cordless lighting manufacture

Working with us to get professional specialists and international designers together to develop innovative new products you wish. Researched, developed, manufactured and tested at our state-of-the-art production facilities.

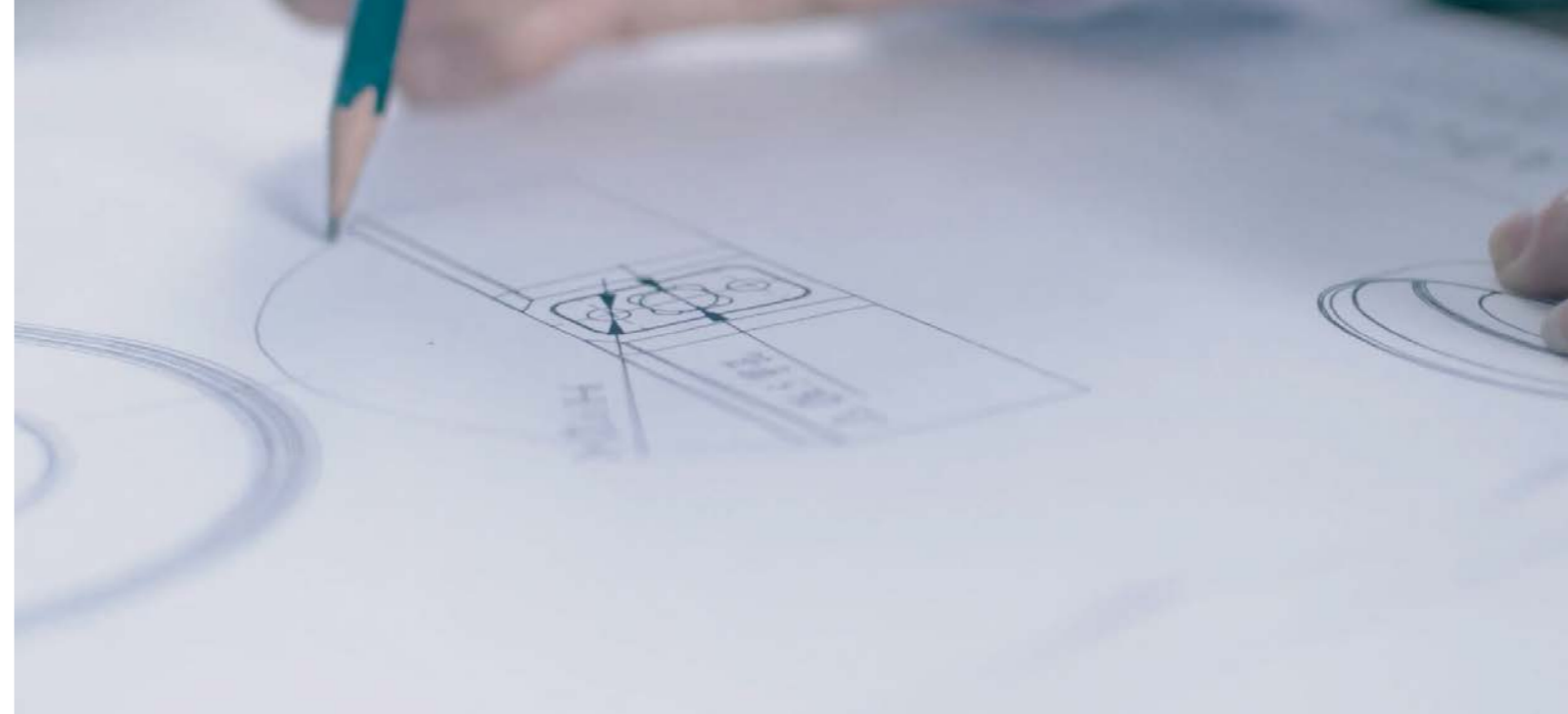

Make your arrangement with us

Creating relaxing atmosphere is key to our believing, and when it comes to luminaires, they're achieved through products that combine comfort, quality and aesthetic pleasure. our mission has never been simply to produce durable weatherproof lamps. We aim to inspire an outdoor living lifestyle, to help people relax and feel nature.

Verified capacities

Service

- ✦ Minor customization
- ✦ Design-based customization
- ✦ Sample-based customization
- ✦ Full customization
- ✦ Centralized procurement available

Certifications

- ✦ **CE** CE certification
- ✦ **CB** CB certification
- ✦ **EMC** EMC certification
- ✦ **UL** UL certification
- ✦ **LVD** LVD certification

Quality control

- ✦ QA/QC inspectors
- ✦ Testing instruments
- ✦ On-site material inspection
- ✦ Warranty available



Effective R&D Capabilities



OEM & ODM



Vertical Supply Chain



European Designer Team



Customized Service

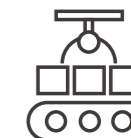

Complete Product Line



Die casting



Cutting



Cleaning



Powder coating



Drilling



Polishing



Assembly



Testing

Quality made

Quality is an importance for us - the quality of our designs, materials, manufacture, service, even the quality of our lives. Whatever we do, it has to be the best for every product. Researched, developed, manufactured and tested at our state-of-the-art production facilities, environmental-friendly material we use is unrivaled for strength, durability, weather fastness.

Made with passion and pride

Along the way, we've developed a special understanding for the needs of our contract partners.

Experience, Versatility, Patience. In the professional area , you'll find all relevant information

and imagery pertaining to our collections always at the ready with fast, comprehensive, professional

support to help you achieve your goals - today, tomorrow and beyond.



Customized your colours

All of our products are available in custom colours. Rich and vibrant colors for a different visual experience. Not only does it bring new life to a minimalist concept, but it also brings detailed decorative elements.

Weather & Atmospheric Resistant Finish

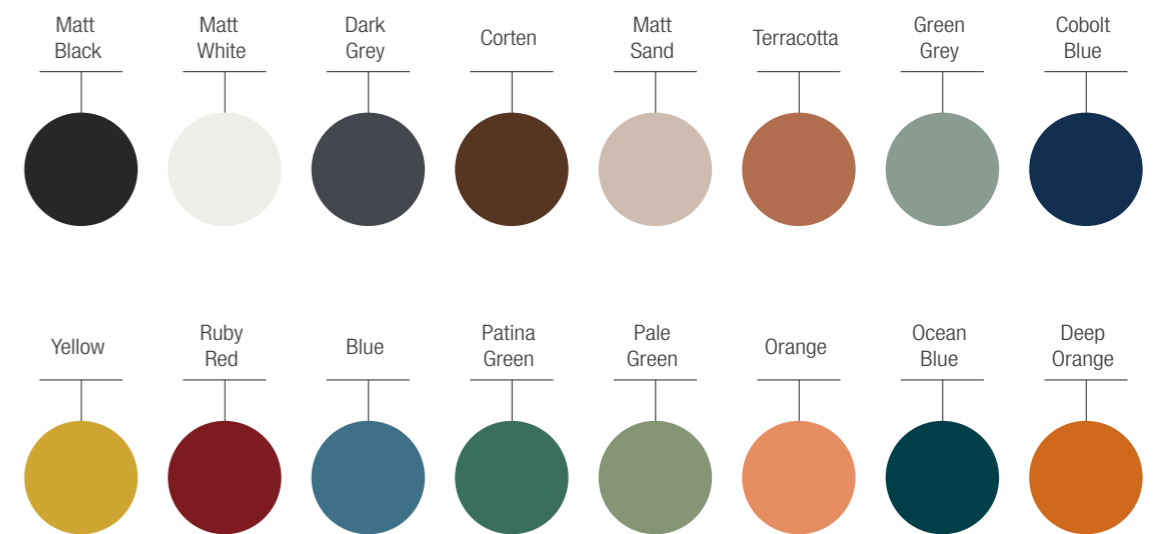

new metallic finish

In autumn 2021, has revamped the rechargeable table lamp with a metallic finish. To complete the range of rechargeable table lamps, has introduced lustre chrome, lustre gold, lustre copper and lustre space grey to meet the functional requirements of modern spaces.

Applicable to the following products:

F1291-CC	F1280-CC	F1103-200E-CC	F1008-200-MC	F1003-360D-CC
F1292-CC	F1221-200-CC	F1103-360E-CC	F1008-300-MC	F1003-200D-CC



F1103-200E-CC



F1221-200-CC



F1292-CC



F1291-CC



F1280-CC



F1003-200D-CC



F1008-200-MC

Lustre Chrome  Lustre Space Gray  Lustre Gold  Lustre Copper 

Index

Total 4 sections

Table Lamps

P. 01-100

With practicality always in mind, the various styles of table lamps ensure that you get the best style you like.

Lanterns/Solar Lamps

P. 101-114

Lanterns are combined with modernist architectural style and new energy solar together.

Floor Lamps

P. 115-126

Combine with new technology, the soft light shines through the clean lines to create a comfortable atmosphere as the night draws in.

Accessories

P. 127-134

Accessories include various charging shelves to provide convenient charging options for HeReCa and give customers more freedom to give the product different applications.



TABLE LAMPS

UCOME CORDLESS

GLORIA NEW
Micro



F1001S-200A-CC
P.06

ALICE NEW
Micro



F1002S-200A-CC
P.08

DAISY NEW
Micro



F1003S-200D-CC
P.10

BELLS NEW
Micro



F1008S-200D-CC
P.12

BELLA NEW
Micro



F1100S-200B-CC
P.14

AGNES NEW
Micro



F1103S-200E-CC
P.16

NORDIC NEW
Micro



F1930S-CC
P.18

BOWLING NEW
Micro



F1940-CC
P.20

FIONA NEW
Micro



F1840S-250-CC
P.22

VENUS NEW
RGB



F1840-300-CC
P.24

WAND NEW



F1640-200-CC
P.26

WAND NEW



F1640-360-CC
P.26

MARS NEW
Magnetic Charging



F1950-220-MC
P.30

JOZO NEW
PC shade



F1613-180-CC
P.32

JOZO NEW
Glass shade



F1614-180-CC
P.32

OPHIR
RGB



F1280-CC
P.34

TABLE LAMPS

UCOME CORDLESS

CONE NEW



F1009-270-CC
P.36

OLIVER NEW



F1880-210-CC
P.38

RETRO NEW



F1830-250-CC
P.40

FLIP



F1020-270-CC
P.42

SQUARE NEW
Magnetic Charging



F1800-200-MC
P.44

ELF



F1220-200-CC
P.46

ELF



F1221-200-CC
P.46

CROLY NEW



F1810-240-CC
P.48

COOLER NEW
Winecooler
RGB



F1760-CC
P.52

CORE



F1600L-250-CC
P.56

CORE NEW
Winecooler
A0010



F1601L-250-CC
P.56

CORE
Bowl
A0012



F1603L-250-CC
P.56

CORE



F1600S-250-CC
P.58

CORE
Vase
A0009



F1601S-250-CC
P.58

GLOW
Vase
A0007



F1291-CC
P.60

GLOW
Candle
A0008



F1292-CC
P.60

TABLE LAMPS

UCOME CORDLESS

VOGUE
Wood



F1230-270-CC
P.64

VOGUE
Chrome colour matching



F1231-270-CC
P.66

VOGUE
Powder coating



F1232-270-CC
P.68

VOGUE
PC shade



F1233-270-CC
P.68

DORA **NEW**



F1234-290-CC
P.70

DEMI **NEW**



F1734-270-CC
P.72

DECO **NEW**



F1641-280-CC
P.74

HOOK
USB Type C
Charging



F1250-360
P.76

JUPITER **NEW**



F1851-300-CC
P.78

SATURN **NEW**



F1861-300-CC
P.80

MERCURY **NEW**
Micro



F1730S-250-CC
P.84

PLUTO **NEW**
Micro



F1731S-250-CC
P.86

FOLDS



F1001-360A-CC
P.88

BLOW



F1002-360A-CC
P.90

DREAM



F1003-200D-CC
P.92

DREAM



F1003-360D-CC
P.92

TABLE LAMPS

UCOME CORDLESS

BELL
Magnetic
Charging



F1008-200-MC
P.94

BELL
Magnetic
Charging



F1008-300-MC
P.94

BASIC



F1100-300B-CC
P.96

BASIC



F1100-360B-CC
P.96

MAYA



F1103-200E-CC
P.98

MAYA



F1103-360E-CC
P.98

SERIF
USB Type C
Charging



F1260-340-CC
P.100

LANTERNS

UCOME CORDLESS

TERRACE

Magnetic Charging



F1621S-MC
P.104

TERRACE

Magnetic Charging

USB Type C Charging



F1621L-MC
P.104

JAR

Solar hybrid

USB Type C Charging



F9030-300
P.106

JAR

Solar hybrid

USB Type C Charging



F9030-450
P.106

TAKE ME

USB Type C Charging



F1030-300
P.108

TAKE ME

USB Type C Charging



F1030-500
P.108

BAY

USB Type C Charging



F1012-300B
P.110

BAY

USB Type C Charging



F1012-500B
P.110

SUNNY

Solar hybrid

USB Type C Charging



F9000-300B
P.112

SUNNY

Solar hybrid

USB Type C Charging

Wall



A0306



F9000-300B
P.112

SUNNY

Solar hybrid

USB Type C Charging



F9001-500B
P.112

SUNNY

Solar hybrid

USB Type C Charging

Wall



A0306



F9001-500B
P.112

CHARM



E1230-380-CC
P.114

FLOOR LAMPS

UCOME CORDLESS

APOLLO

RGB



F2000-1500A-CC
P.118

SOLO **NEW**

Solar hybrid

Solar hybrid

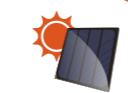

F2002-1500A-CC
P.122

DREAM FLOOR **NEW**

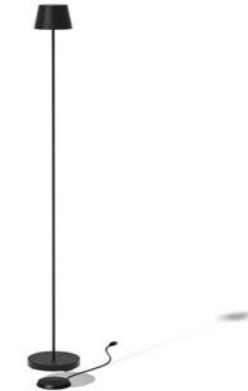

F1003-1200-CC
P.124

ELF FLOOR

Magnetic Charging



F1220-1200-MC
P.126

ACCESSORIES

UCOME CORDLESS

6 multiple contact charging shelf



A0201
P.130

NEW 6 multiple magnetic contact charging shelf



A0214
P.131

NEW Micro 15 multiple contact charging shelf



A0217
P.132

NEW Trolley



A0218
P.134

TABLE LAMPS

With practicality always in mind, the various styles of table lamps ensure that you get the best style you like.

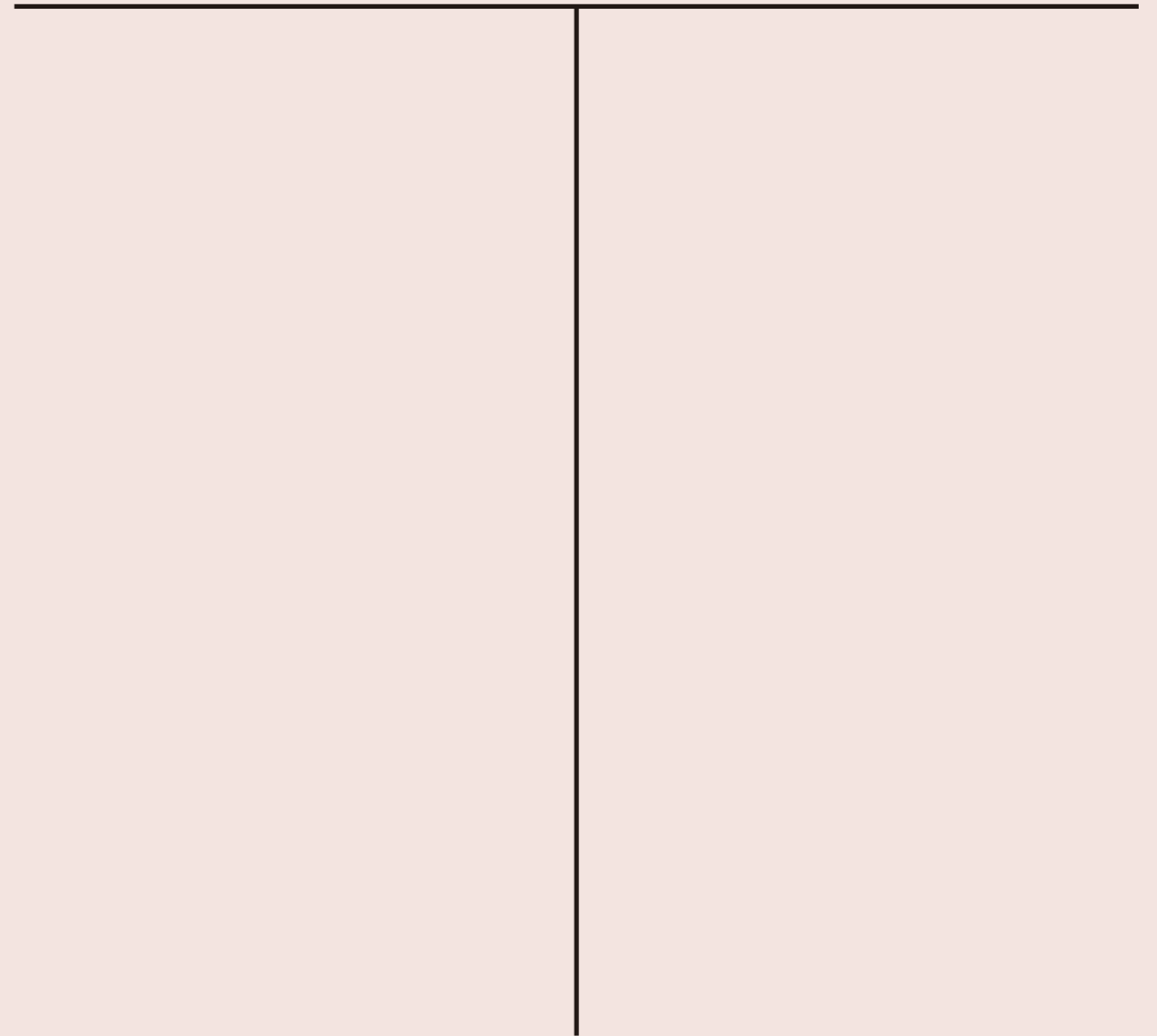
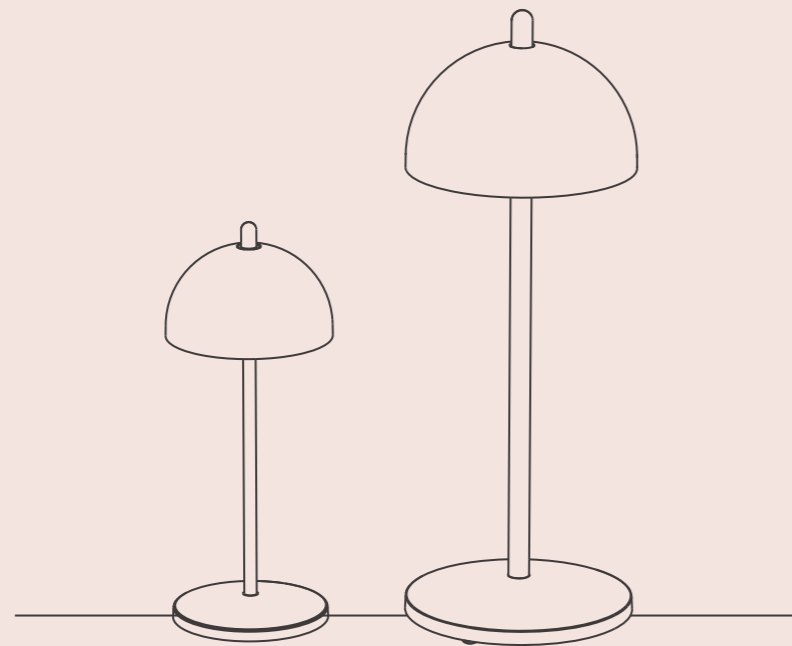

New Micro Series

New micro series includes 9 mini table lamps, they are GLORIA, ALICE, DAISY, BELLS, BELLA, AGNES, NORDIC, BOWING, FLONA. In the case of the original function remains unchanged, the series than the previous conventional series down 40% of the volume as well as 30% of the price, is a good choice for outdoor and home life, but also suitable for HeReCa use.





GLORIA

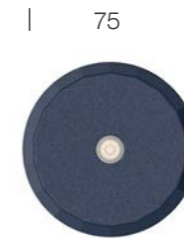

TECHNICAL INFORMATION

LEDs: OSRAM SMD2835 / CRI≥80 / 2.2W / DC3.7V / 160lm

Switch: Touch ON/OFF / Stepless dimmable 5%-100% / Colour temperature 2200K&3000K / Memory function

Battery: Li-ion battery / 3000mAh / Charge time≤4.5hours / Working time≥9.5hours(100% light intensity)

Adapter(Optional): CLASSII / Input AC100-240V / Output DC5V1A

Micro multi contact charging shelf(optional): Stackable up to 3 levels. One charger shelf charges 15 table lamps together.

Others: Safety ClassIII / IP65 / Weight 425g

FINISH AVAILABLE

- | | | | | | | | |
|------------|--|------------|--|-----------------|--|-------------|--|
| Dark Grey | | Matt White | | Terracotta | | Cobalt Blue | |
| Matt Black | | Corten | | Matt Green Grey | | Matt Sand | |

CONTACT CHARGING



Item No.: A0215

Description: Table lamp round shape single charger (contact charging base).



Smaller, Lighter



ALICE



TECHNICAL INFORMATION

LEDs: OSRAM SMD2835 / CRI≥80 / 2.2W / DC3.7V / 160lm

Switch: Touch ON/OFF / Stepless dimmable 5%-100% / Colour temperature 2200K&3000K / Memory function

Battery: Li-ion battery / 3000mAh / Charge time≤4.5hours / Working time≥9.5hours(100% light intensity)

Adapter(Optional): CLASSII / Input AC100-240V / Output DC5V1A

Micro multi contact charging shelf(optional): Stackable up to 3 levels. One charger shelf charges 15 table lamps together.

Others: Safety ClassIII / IP65 / Weight 330g

FINISH AVAILABLE

Dark Grey		Matt White		Terracotta		Cobalt Blue	
Matt Black		Corten		Matt Green Grey		Matt Sand	

CONTACT CHARGING



Item No.: A0215

Description: Table lamp round shape single charger (contact charging base).





TABLE LAMPS

Item No.: F1003S-200D-CC

DAISY

| 76 |



TECHNICAL INFORMATION

LEDs: OSRAM SMD2835 / CRI≥80 / 2.2W / DC3.7V / 160lm

Switch: Touch ON/OFF / Stepless dimmable 5%-100% / Colour temperature 2200K&3000K / Memory function

Battery: Li-ion battery / 3000mAh / Charge time≤4.5hours / Working time≥9.5hours(100% light intensity)

Adapter(Optional): CLASSII / Input AC100-240V / Output DC5V1A

Micro multi contact charging shelf(optional): Stackable up to 3 levels. One charger shelf charges 15 table lamps together.

Others: Safety ClassIII / IP65 / Weight 418g

FINISH AVAILABLE

- | | | | | | | | |
|------------|---|------------|---|-----------------|---|-------------|---|
| Dark Grey |  | Matt White |  | Terracotta |  | Cobalt Blue |  |
| Matt Black |  | Corten |  | Matt Green Grey |  | Matt Sand |  |

CONTACT CHARGING



Item No.: A0215

Description: Table lamp round shape single charger (contact charging base).





TABLE LAMPS

Item No.: F1008S-200D-CC

BELLS



TECHNICAL INFORMATION

LEDs: OSRAM SMD2835 / CRI≥80 / 2.2W / DC3.7V / 160lm

Switch: Touch ON/OFF / Stepless dimmable 5%-100% / Colour temperature 2200K&3000K / Memory function

Battery: Li-ion battery / 3000mAh / Charge time≤4.5hours / Working time≥9.5hours(100% light intensity)

Adapter(Optional): CLASSII / Input AC100-240V / Output DC5V1A

Micro multi contact charging shelf(optional): Stackable up to 3 levels. One charger shelf charges 15 table lamps together.

Others: Safety ClassIII / IP65 / Weight 356g

FINISH AVAILABLE

- Dark Grey
- Matt White
- Terracotta
- Cobalt Blue
- Matt Black
- Corten
- Matt Green Grey
- Matt Sand

CONTACT CHARGING



Item No.: A0215

Description: Table lamp round shape single charger (contact charging base).





TABLE LAMPS

Item No.: F1100S-200B-CC

BELLA



TECHNICAL INFORMATION

LEDs: OSRAM SMD2835 / CRI≥80 / 2.2W / DC3.7V / 160lm

Switch: Touch ON/OFF / Stepless dimmable 5%-100% / Colour temperature 2200K&3000K / Memory function

Battery: Li-ion battery / 3000mAh / Charge time≤4.5hours / Working time≥9.5hours(100% light intensity)

Adapter(Optional): CLASSII / Input AC100-240V / Output DC5V1A

Micro multi contact charging shelf(optional): Stackable up to 3 levels. One charger shelf charges 15 table lamps together.

Others: Safety ClassIII / IP65 / Weight 340g

FINISH AVAILABLE

- | | | | | | | | |
|------------|--|------------|--|-----------------|--|-------------|--|
| Dark Grey | | Matt White | | Terracotta | | Cobalt Blue | |
| Matt Black | | Corten | | Matt Green Grey | | Matt Sand | |

CONTACT CHARGING



Item No.: A0216

Description: Table lamp square shape single charger (contact charging base).





TABLE LAMPS

Item No.: F1103S-200E-CC

AGNES

| 67 |



TECHNICAL INFORMATION

LEDs: OSRAM SMD2835 / CRI≥80 / 2.2W / DC3.7V / 160lm

Switch: Touch ON/OFF / Stepless dimmable 5%-100% / Colour temperature 2200K&3000K / Memory function

Battery: Li-ion battery / 3000mAh / Charge time≤4.5hours / Working time≥9.5hours(100% light intensity)

Adapter(Optional): CLASSII / Input AC100-240V / Output DC5V1A

Micro multi contact charging shelf(optional): Stackable up to 3 levels. One charger shelf charges 15 table lamps together.

Others: Safety ClassIII / IP65 / Weight 425g

FINISH AVAILABLE

- | | | | | | | | |
|------------|--|------------|--|-----------------|--|-------------|--|
| Dark Grey | | Matt White | | Terracotta | | Cobalt Blue | |
| Matt Black | | Corten | | Matt Green Grey | | Matt Sand | |

CONTACT CHARGING



Item No.: A0216

Description: Table lamp square shape single charger (contact charging base).





TABLE LAMPS

Item No.: F1930S-CC

NORDIC



TECHNICAL INFORMATION

LEDs: OSRAM SMD2835 / CRI≥80 / 3.2W / DC3.7V / 260lm

Switch: Press ON/OFF / Stepless dimmable 5%-100% / Colour temperature 2200K-4000K / Memory function

Battery: Li-ion battery / 3000mAh / Charge time≤4.5hours / Working time≥7hours(100% light intensity)

Adapter(Optional): CLASSII / Input AC100-240V / Output DC5V1A

Multi contact charging shelf(optional): Stackable up to 3 levels. One charger shelf charges 6 table lamps together.

Others: Safety ClassIII / IP65

FINISH AVAILABLE 1



FINISH AVAILABLE 2



CONTACT CHARGING



Item No.: A0208

Description: Table lamp round shape single charger (contact charging base).





TABLE LAMPS

Item No.: F1940-CC

BOWLING



LOGO Customized

TECHNICAL INFORMATION

LEDs: OSRAM SMD2835 / CRI≥80 / 2.5W / DC3.7V / 156lm

Switch: Touch ON/OFF / Stepless dimmable 5%-100% / Colour temperature 2200K&3000K / Memory function

Battery: Li-ion battery / 3000mAh / Charge time≤5hours / Working time≥9hours(100% light intensity)

Adapter(Optional): CLASSII / Input AC100-240V / Output DC5V1A

Micro multi contact charging shelf(optional): Stackable up to 3 levels. One charger shelf charges 15 table lamps together.

Others: Safety ClassIII / IP65 / Weight 379g

FINISH AVAILABLE

- Dark Grey
- Matt White
- Terracotta
- Cobalt Blue
- Matt Black
- Corten
- Matt Green Grey
- Matt Sand

CONTACT CHARGING



Item No.: A0208

Description: Table lamp round shape single charger (contact charging base).





TABLE LAMPS

Item No.: F1840S-250-CC

FIONA

| 76 |



256

TECHNICAL INFORMATION

LEDs: OSRAM SMD2835 / CRI≥80 / 2.5W / DC3.7V / 160lm

Switch: Touch ON/OFF / Stepless dimmable 5%-100% / Colour temperature 2200K&2700K / Memory function

Battery: Li-ion battery / 3000mAh / Charge time≤4.5hours / Working time≥9.5hours(100% light intensity)

Adapter(Optional): CLASSII / Input AC100-240V / Output DC5V1A

Micro multi contact charging shelf(optional): Stackable up to 3 levels. One charger shelf charges 15 table lamps together.

Others: Safety ClassIII / IP65

FINISH AVAILABLE

- | | | | | | | | |
|------------|--|------------|--|-----------------|--|-------------|--|
| Dark Grey | | Matt White | | Terracotta | | Cobalt Blue | |
| Matt Black | | Corten | | Matt Green Grey | | Matt Sand | |

CONTACT CHARGING



Item No.: A0208

Description: Table lamp round shape single charger (contact charging base).





TABLE LAMPS

Item No.: F1840-300-CC

VENUS



TECHNICAL INFORMATION

LEDs: OSRAM SMD2835 / CRI≥80 / 2.5W / DC3.7V / 159lm

Switch: Touch ON/OFF / Stepless dimmable 5%-100% /
 Colour temperature: 2700K&3000K&4000K (switchable) /
 RGB: Red, orange, yellow, green, cyan, blue & purple (switchable) /
 Memory function: Memory of brightness, colour temperature and RGB



Battery: Li-ion battery / 3000mAh / Charge time≤5hours /
 Working time≥8.5hours(100% light intensity)

Adapter(Optional): CLASSII / Input AC100-240V / Output DC5V1A

Multi contact charging shelf(optional): Stackable up to 3 levels.
 One charger shelf charges 6 table lamps together.

Others: Safety ClassIII / IP65 / Weight 600g

FINISH AVAILABLE

- | | | | |
|------------|------------|-----------------|-------------|
| Dark Grey | Matt White | Terracotta | Cobalt Blue |
| Matt Black | Corten | Matt Green Grey | Matt Sand |

CONTACT CHARGING



Item No.: A0208

Description: Table lamp round shape single charger (contact charging base).





TABLE LAMPS

Item No.: F1640-200-CC
F1640-360-CC

WAND

| 100 |



F1640-200-CC

200



F1640-360-CC

360

TECHNICAL INFORMATION

LEDS: CREE SMD3030/ CRI≥80 / 2.6W / DC3.7V / 166lm

Switch: Press ON/OFF / Stepless dimmable 5%-100% / Colour temperature 3000K / Memory function

Battery: Li-ion battery / 4400mAh / Charge time≤6.5hours / Working time≥11hours(100% light intensity)

Adapter(Optional): CLASSII / Input AC100-240V / Output DC5V1A

Multi contact charging shelf(optional): Stackable up to 3 levels. One charger shelf charges 6 table lamps together.

Others: Safety ClassIII / IP65 / Weight 560g 638g

FINISH AVAILABLE

- | | | | |
|------------|------------|-----------------|-------------|
| Dark Grey | Matt White | Terracotta | Cobalt Blue |
| Matt Black | Corten | Matt Green Grey | Matt Sand |

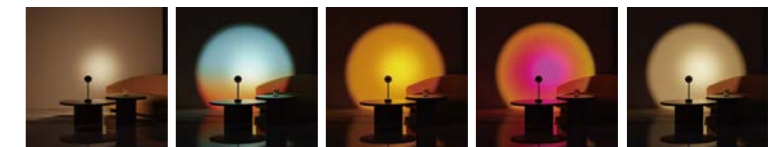

Reading Lamp Dawnbreak Sunset Sunset Red Spotlight

CONTACT CHARGING



Item No.: A0208

Description: Table lamp round shape single charger (contact charging base).



MARS

Thanks to MARS's compact size and excellent water resistance, it is ideally suited to both indoor and outdoor use. Avant-garde technology gives MARS a powerful function wherever it is used, and MARS looks like a work of art, adding a sense of literature and elegance to homes, restaurants, cafes, hotel lobbies, etc.

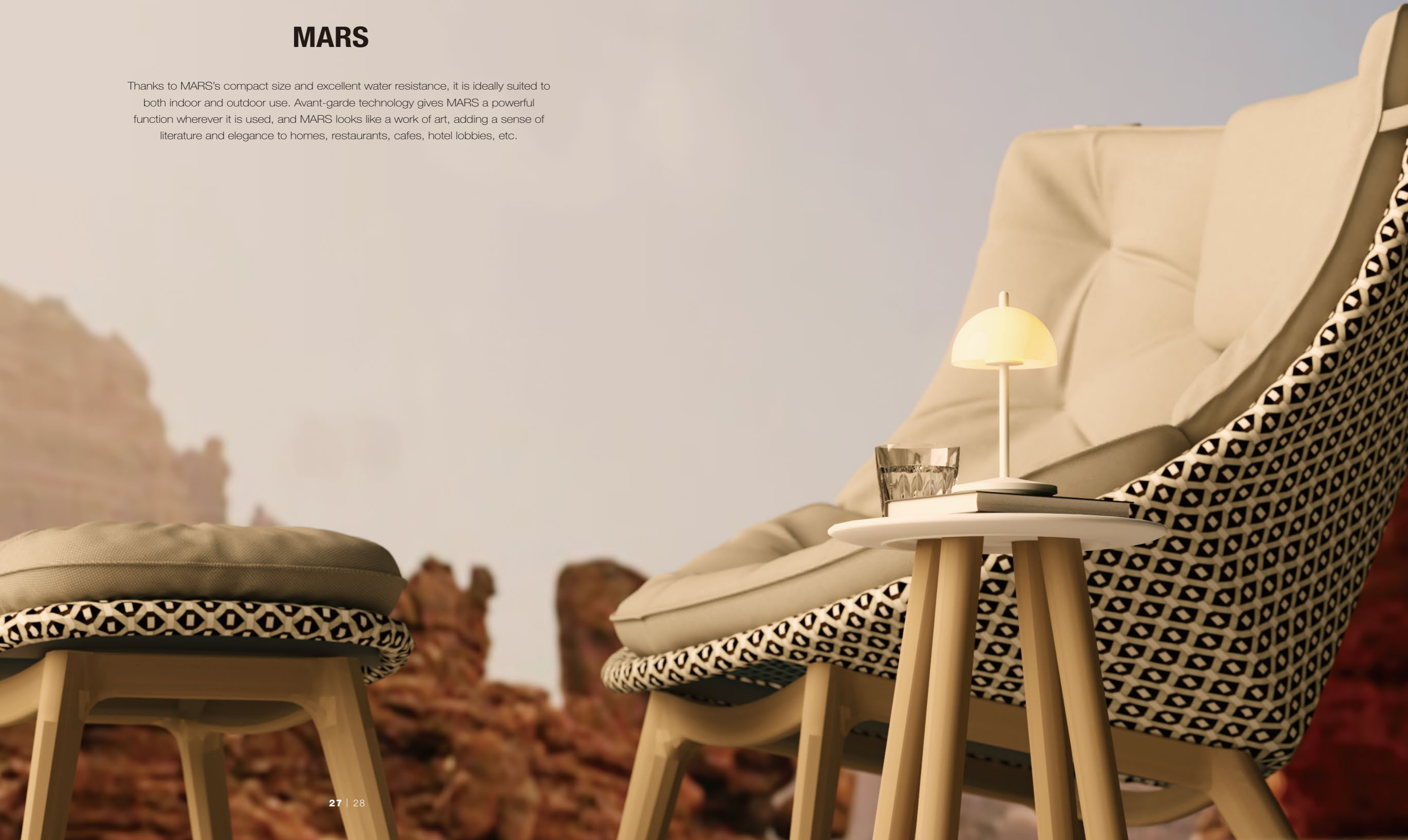

MARS



TECHNICAL INFORMATION

LEDs: OSRAM SMD2835 / CRI≥80 / 2.5W / DC3.7V / 167lm

Switch: Touch ON/OFF / Stepless dimmable 5%-100% / Colour temperature 2200K&3000K / Memory function

Battery: Li-ion battery / 3000mAh / Charge time≤5hours / Working time≥10hours(100% light intensity)

Adapter(Optional): CLASSII / Input AC100-240V / Output DC5V1A

Multi magnetic contact charging shelf(optional): Stackable up to 3 levels. One charger shelf charges 6 table lamps together.

Others: Safety ClassIII / IP65 / Weight 324g

FINISH AVAILABLE

- | | | | | | | | |
|------------|--|------------|--|-----------------|--|-------------|--|
| Dark Grey | | Matt White | | Terracotta | | Cobalt Blue | |
| Matt Black | | Corten | | Matt Green Grey | | Matt Sand | |

MAGNETIC CHARGING



Item No.: A0212

Magnetic contact charging system: 1.5m USB cable included.





TABLE LAMPS

Item No.: F1613-180-CC
F1614-180-CC

JOZO



TECHNICAL INFORMATION

LEDS: SMD3030 / CRI>80 / 2.5W / DC3.7V / 151lm

Switch: Press ON/OFF / Stepless dimmable 5%-100% / Colour temperature 2700K&3000K / Memory function

Battery: Li-ion battery / 4400mAh / Charge time≤6.2hours / Working time≥10.5hours(100% light intensity)

Adapter(Optional): CLASSII / Input AC100-240V / Output DC5V1A

Multi contact charging shelf(optional): Stackable up to 3 levels. One charger shelf charges 6 table lamps together.

Others: Safety ClassIII / IP65

FINISH AVAILABLE

- | | | | | | | | |
|------------|--|------------|--|-----------------|--|-------------|--|
| Dark Grey | | Matt White | | Terracotta | | Cobalt Blue | |
| Matt Black | | Corten | | Matt Green Grey | | Matt Sand | |

CONTACT CHARGING



Item No.: A0208

Description: Table lamp round shape single charger (contact charging base).



OPHIR



TECHNICAL INFORMATION

LEDs: OSRAM SMD2835 / CRI≥80 / 2.5W / DC3.7V / 200lm

Switch: Press ON/OFF / Stepless dimmable 5%-100% /
 Colour temperature: 2700K&3000K&4000K (switchable)
 RGB: Red, orange, yellow, green, cyan, blue & purple (switchable) /
 Memory function: Memory of brightness, colour temperature and RGB



Battery: Li-ion battery / 4400mAh / Charge time≤7hours /
 Working time≥9hours(100% light intensity)

Adapter(Optional): CLASSII / Input AC100-240V / Output DC5V1A

Multi contact charging shelf(optional): Stackable up to 3 levels.
 One charger shelf charges 6 table lamps together.

Others: Safety ClassIII / IP65 / Weight 845g

FINISH AVAILABLE

- | | | | |
|---------------|-------------|-------------------|---------------|
| Dark Grey | Matt White | Orange | Blue |
| Matt Black | Corten | Matt Green Grey | Yellow |
| Lustre Chrome | Lustre Gold | Lustre Space Grey | Lustre Copper |

CONTACT CHARGING



Item No.: A0208

Description: Table lamp round shape single charger (contact charging base).

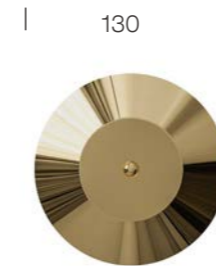



TABLE LAMPS

Item No.: F1009-270-CC

CONE



TECHNICAL INFORMATION

LEDs: OSRAM SMD2835 / CRI≥80 / 2.5W / DC3.7V / 180lm

Switch: Press ON/OFF / Stepless dimmable 5%-100% / Colour temperature 2700K-4000K / Memory function

Battery: Li-ion battery / 4400mAh / Charge time≤6.5hours / Working time≥11hours(100% light intensity)

Adapter(Optional): CLASSII / Input AC100-240V / Output DC5V1A

Multi contact charging shelf(optional): Stackable up to 3 levels. One charger shelf charges 6 table lamps together.

Others: Safety ClassIII / IP65

FINISH AVAILABLE

- | | | | | | | | |
|---------------|--|-------------|--|-----------------|--|-------------|--|
| Dark Grey | | Matt White | | Terracotta | | Cobalt Blue | |
| Matt Black | | Corten | | Matt Green Grey | | Matt Sand | |
| Lustre Chrome | | Lustre Gold | | Lustre Copper | | | |

CONTACT CHARGING



Item No.: A0203

Description: Table lamp round shape single charger (contact charging base).





TABLE LAMPS

Item No.: F1880-210-CC

OLIVER



TECHNICAL INFORMATION

LEDs: OSRAM SMD2835 / CRI≥80 / 3.1W / DC3.7V / 220lm

Switch: Press ON/OFF / Knob stepless dimmable 5%-100% / Colour temperature 2700K-4000K / Memory function

Battery: Li-ion battery / 4400mAh / Charge time≤5.5hours / Working time≥8.2hours(100% light intensity)

Adapter(Optional): CLASSII / Input AC100-240V / Output DC5V1A

Multi contact charging shelf(optional): Stackable up to 3 levels. One charger shelf charges 6 table lamps together.

Others: Safety ClassIII / IP65 / Weight 792g

FINISH AVAILABLE

- | | | | | | | | |
|---------------|--|-------------|--|-----------------|--|-------------|--|
| Dark Grey | | Matt White | | Terracotta | | Cobalt Blue | |
| Matt Black | | Corten | | Matt Green Grey | | Matt Sand | |
| Lustre Chrome | | Lustre Gold | | Lustre Copper | | | |

CONTACT CHARGING



Item No.: A0203

Description: Table lamp round shape single charger (contact charging base).





TABLE LAMPS

Item No.: F1830-250-CC

RETRO



TECHNICAL INFORMATION

LEDs: OSRAM SMD2835 / CRI≥80 / 2.5W / DC3.7V / 248lm

Switch: Press ON/OFF / Knob stepless dimmable 5%-100% / Colour temperature 2700K-4000K / Memory function

Battery: Li-ion battery / 4400mAh / Charge time≤6.4hours / Working time≥8.6hours(100% light intensity)

Adapter(Optional): CLASSII / Input AC100-240V / Output DC5V1A

Multi contact charging shelf(optional): Stackable up to 3 levels. One charger shelf charges 6 table lamps together.

Others: Safety ClassIII / IP65 / Weight 1000g

FINISH AVAILABLE

- | | | | | | | | |
|------------|--|------------|--|-----------------|--|-------------|--|
| Dark Grey | | Matt White | | Terracotta | | Cobalt Blue | |
| Matt Black | | Corten | | Matt Green Grey | | Matt Sand | |

CONTACT CHARGING



Item No.: A0208

Description: Table lamp round shape single charger (contact charging base).





TABLE LAMPS

Item No.: F1020-270-CC

FLIP



TECHNICAL INFORMATION

Filament style LED / CRI≥80 / 1.8W / DC3.7V / 100lm

Switch: Touch ON/OFF / Stepless dimmable 5%-100% / Colour temperature 2200K / Memory function

Battery: Li-ion battery / 4400mAh / Charge time≤7hours / Working time≥10hours(100% light intensity)

Adapter(Optional): CLASSII / Input AC100-240V / Output DC5V1A

Others: Safety ClassIII / IP65 / Weight 840g

FINISH AVAILABLE

- | | | | | | | | |
|------------|--|------------|--|------------|--|-------------|--|
| Dark Grey | | Matt White | | Ruby Red | | Cobalt Blue | |
| Matt Black | | Corten | | Pale Green | | Matt Sand | |

CONTACT CHARGING



Item No.: A0208

Description: Table lamp round shape single charger (contact charging base).





TABLE LAMPS

Item No.: F1800-200-MC

SQUARE

| 79 |



200



TECHNICAL INFORMATION

LEDs: OSRAM SMD2835 / CRI≥80 / 2.5W / DC3.7V / 179lm

Switch: Touch ON/OFF / Stepless dimmable 5%-100% / Colour temperature 2700K&3000K / Memory function

Battery: Li-ion battery / 4400mAh / Charge time≤6.4hours / Working time≥11hours(100% light intensity)

Adapter(Optional): CLASSII / Input AC100-240V / Output DC5V1A

Multi magnetic contact charging shelf(optional): Stackable up to 3 levels. One charger shelf charges 6 table lamps together.

Others: Safety ClassIII / IP65 / Weight 350g

FINISH AVAILABLE

- | | | | | | | | |
|---------------|--|-------------|--|-----------------|--|-------------|--|
| Dark Grey | | Matt White | | Terracotta | | Cobalt Blue | |
| Matt Black | | Corten | | Matt Green Grey | | Matt Sand | |
| Lustre Chrome | | Lustre Gold | | Lustre Copper | | | |

MAGNETIC CHARGING



Item No.: A0212

Magnetic contact charging system: 1.5m USB cable included.





TABLE LAMPS

Item No.: F1220-200-CC
F1221-200-CC

ELF

| 90 |



200

TECHNICAL INFORMATION

LEDs: OSRAM SMD2835 / CRI≥80 / 2.5W / DC3.7V / 202lm

Switch: Touch ON/OFF / Stepless dimmable 5%-100% / Colour temperature 2700K&3000K / Memory function

Battery: Li-ion battery / 4400mAh / Charge time≤6.4hours / Working time≥9hours(100% light intensity)

Adapter(Optional): CLASSII / Input AC100-240V / Output DC5V1A

Multi contact charging shelf(optional): Stackable up to 3 levels. One charger shelf charges 6 table lamps together.

Others: Safety ClassIII / IP65 / Weight 490g

FINISH AVAILABLE

- | | | | | | | | |
|---------------|--|-------------|--|-------------------|--|---------------|--|
| Dark Grey | | Matt White | | Matt Black | | Corten | |
| Lustre Chrome | | Lustre Gold | | Lustre Space Grey | | Lustre Copper | |

CONTACT CHARGING



Item No.: A0206

Description: Table lamp round shape single charger (contact charging base).





TABLE LAMPS

Item No.: F1810-240-CC

CROLY



TECHNICAL INFORMATION

LEDs: OSRAM SMD2835 / CRI≥80 / 2.5W / DC3.7V / 200lm

Switch: Touch ON/OFF / Stepless dimmable 5%-100% / Colour temperature 2700K&3000K / Memory function

Battery: Li-ion battery / 4400mAh / Charge time≤6.5hours / Working time≥9hours(100% light intensity)

Adapter(Optional): CLASSII / Input AC100-240V / Output DC5V1A

Multi contact charging shelf(optional): Stackable up to 3 levels. One charger shelf charges 6 table lamps together.

Others: Safety ClassIII / IP65

FINISH AVAILABLE

- | | | | | | | | |
|---------------|--|-------------|--|-----------------|--|-------------|--|
| Dark Grey | | Matt White | | Terracotta | | Cobalt Blue | |
| Matt Black | | Corten | | Matt Green Grey | | Matt Sand | |
| Lustre Chrome | | Lustre Gold | | Lustre Copper | | | |

CONTACT CHARGING



Item No.: A0208

Description: Table lamp round shape single charger (contact charging base).



More than Lamps

Functional series is an innovative portable rechargeable lamp. The lamp body is made of aluminum die-casting, forming a simple and atmospheric geometric shape. Its mission is not only lighting, but also highly decorative and practical.



F1291-CC
P.60

VASE



F1601S-250-CC
P.58

CORE



New Winecooler

COOLER

 **Ice box: for cooling wine**

F1760-CC
P.52



CORE

bowl

F1603L-250-CC
P.56



CORE

Winecooler

F1601L-250-CC
P.56



TABLE LAMPS

Item No.: F1760-CC

COOLER



Winecooler

TECHNICAL INFORMATION

LEDs: OSRAM SMD2835 / CRI≥80 / 3W / DC3.7V / 256lm

Switch: Press ON/OFF / Stepless dimmable 5%-100% /
 Colour temperature: 2700K&3000K&4000K (switchable) /
 RGB: Red, orange, yellow, green, cyan, blue & purple (switchable) /
 Memory function: Memory of brightness, colour temperature and RGB



Battery: Li-ion battery / 6600mAh / Charge time≤7.5hours /
 Working time≥10.5hours(100% light intensity)

Adapter(Optional): CLASSII / Input AC100-240V / Output DC5V1A

Others: Safety ClassIII / IP65 / Weight 2000g

FINISH AVAILABLE

- | | | | |
|------------|------------|-----------------|-------------|
| Dark Grey | Matt White | Terracotta | Cobalt Blue |
| Matt Black | Corten | Matt Green Grey | Matt Sand |

CONTACT CHARGING



Item No.: A0206

Description: Table lamp round shape single charger (contact charging base).

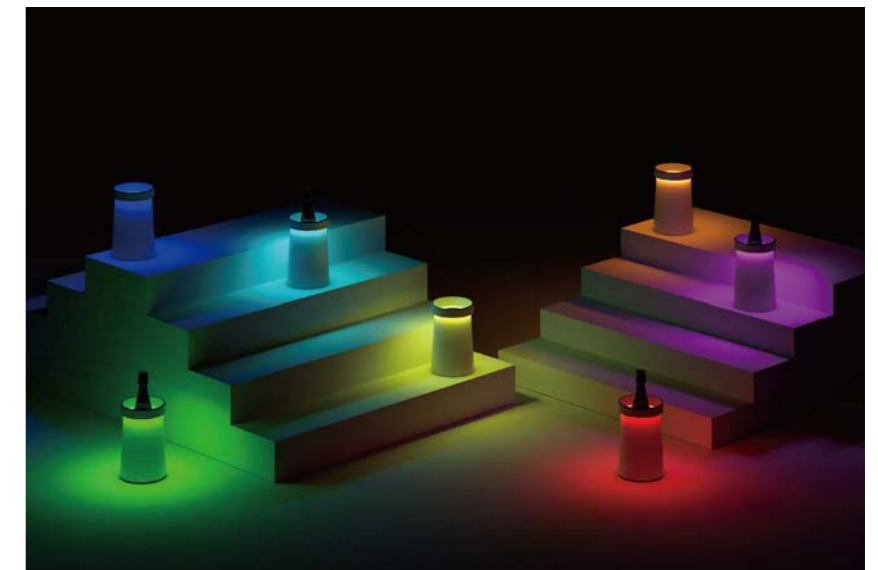

CORE

CORE has three detachable accessories, a hollow glass tube for flower arrangement, a hollow glass barrel for ice red wine, and a glass bowl for fruit and bread. No matter which scene the core is placed in, it can attract our attention and become the protagonist. This is its charm.





TABLE LAMPS

Item No.: F1600L-250-CC
F1601L-250-CC
F1603L-250-CC

CORE



TECHNICAL INFORMATION

LEDs: OSRAM SMD2835 / CRI≥80 / 3.3W / DC3.7V / 300lm

Switch: Touch ON/OFF / Stepless dimmable 5%-100% / Colour temperature 2700K&3000K / Memory function

Battery: Li-ion battery / 4400mAh / Charge time≤6.5hours / Working time≥10hours(100% light intensity)

Adapter(Optional): CLASSII / Input AC100-240V / Output DC5V1A

Others: Safety ClassIII / IP65 / Weight 850g/1450g/1050g

FINISH AVAILABLE

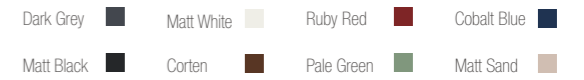

CONTACT CHARGING



Item No.: A0208

Description: Table lamp round shape single charger (contact charging base).





TABLE LAMPS

Item No.: F1600S-250-CC
F1601S-250-CC

CORE



F1600S-250-CC



F1601S-250-CC
Vase

TECHNICAL INFORMATION

LEDs: OSRAM SMD2835 / CRI≥80 / 3.3W / DC3.7V / 270lm

Switch: Touch ON/OFF / Stepless dimmable 5%-100% /
Colour temperature 2700K&3000K / Memory function

Battery: Li-ion battery / 4400mAh / Charge time≤6hours /
Working time≥9hours(100% light intensity)

Adapter(Optional): CLASSII / Input AC100-240V / Output DC5V1A

Multi contact charging shelf(optional): Stackable up to 3 levels.
One charger shelf charges 6 table lamps together.

Others: Safety ClassIII / IP65 / Weight 515g/697g

FINISH AVAILABLE

- | | | | |
|------------|------------|------------|-------------|
| Dark Grey | Matt White | Ruby Red | Cobalt Blue |
| Matt Black | Corten | Pale Green | Matt Sand |

CONTACT CHARGING



Item No.: A0208

Description: Table lamp round shape single
charger (contact charging base).





TABLE LAMPS

Item No.: F1290-CC
F1291-CC
F1292-CC

GLOW



F1290-CC



F1291-CC
Vase

F1292-CC
Candle

TECHNICAL INFORMATION

LEDS: OSRAM SMD3030 / CRI≥80 / 2W / DC3.7V / 150lm

Switch: Button ON/OFF / Knob stepless dimmable 0%-100% / Colour temperature 1800K&3000K&4000K / Memory function

Battery: Li-ion battery / 4400mAh / Charge time≤6hours / Working time≥12hours(100% light intensity)

Adapter(Optional): CLASSII / Input AC100-240V / Output DC5V1A

Others: Safety ClassIII / IP65 / Weight 400g/472g/497g

FINISH AVAILABLE

Matt Black ■ Matt White ■

CONTACT CHARGING



Item No.: A0208

Description: Table lamp round shape single charger (contact charging base).



VOGUE

From more to one. It develops the concept of Minimalism life style to improve human well-being through the technology of high-quality, comfort and sustainability services.





VOGUE



TECHNICAL INFORMATION

LEDS: OSRAM SMD2835 / CRI≥80 / 2.5W / DC3.7V / 200lm

Switch: Press ON/OFF / Stepless dimmable 5%-100% / Colour temperature 2700K&3000K / Memory function

Battery: Li-ion battery / 3000mAh / Charge time≤5hours / Working time≥8hours(100% light intensity)

Adapter(Optional): CLASSII / Input AC100-240V / Output DC5V1A

Multi contact charging shelf(optional): Stackable up to 3 levels. One charger shelf charges 6 table lamps together.

Others: Safety ClassIII / IP65 / Weight 670g

FINISH AVAILABLE

- Dark Grey
-
- Matt White
-
- Matt Black
-
- Corten
-

CONTACT CHARGING



Item No.: A0208

Description: Table lamp round shape single charger (contact charging base).





VOGUE



Chrome colour matching

TECHNICAL INFORMATION

LEDs: OSRAM SMD2835 / CRI≥80 / 2.5W / DC3.7V / 200lm

Switch: Press ON/OFF / Stepless dimmable 5%-100% / Colour temperature 2700K&3000K / Memory function

Battery: Li-ion battery / 4400mAh / Charge time≤6hours / Working time≥9hours(100% light intensity)

Adapter(Optional): CLASSII / Input AC100-240V / Output DC5V1A

Multi contact charging shelf(optional): Stackable up to 3 levels. One charger shelf charges 6 table lamps together.

Others: Safety ClassIII / IP65 / Weight 670g

FINISH AVAILABLE

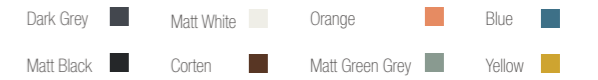

CONTACT CHARGING



Item No.: A0208

Description: Table lamp round shape single charger (contact charging base).





TABLE LAMPS

Item No.: F1232-270-CC
F1233-270-CC

VOGUE



TECHNICAL INFORMATION

LEDs: OSRAM SMD2835 / CRI≥80 / 2.5W / DC3.7V / 200lm

Switch: Press ON/OFF / Stepless dimmable 5%-100% / Colour temperature 2700K&3000K / Memory function

Battery: Li-ion battery / 4400mAh / Charge time≤6hours / Working time≥9hours(100% light intensity)

Adapter(Optional): CLASSII / Input AC100-240V / Output DC5V1A

Multi contact charging shelf(optional): Stackable up to 3 levels. One charger shelf charges 6 table lamps together.

Others: Safety ClassIII / IP65 / Weight 670g

FINISH AVAILABLE

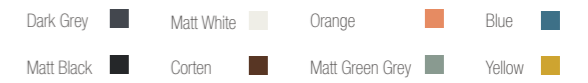

CONTACT CHARGING



Item No.: A0208

Description: Table lamp round shape single charger (contact charging base).

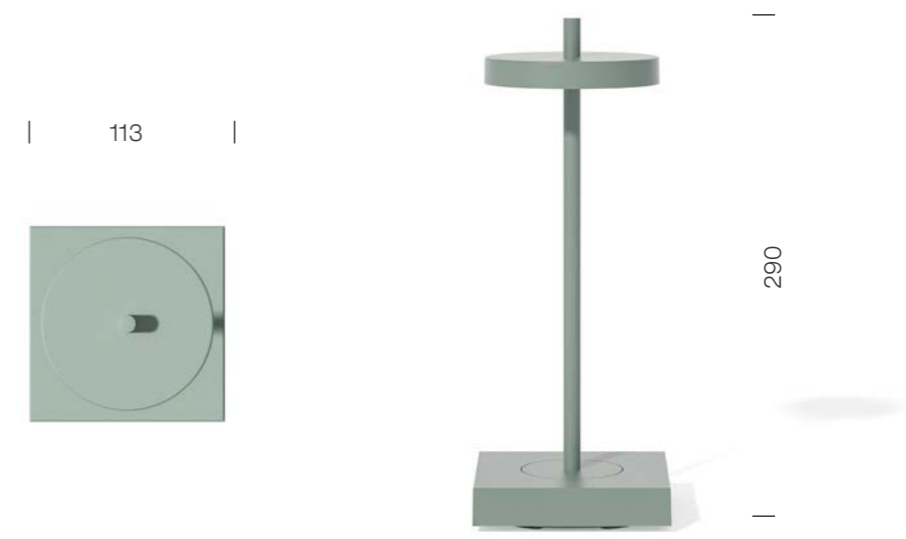



TABLE LAMPS

Item No.: F1234-290-CC

DORA



TECHNICAL INFORMATION

LEDs: OSRAM SMD2835 / CRI≥80 / 2.5W / DC3.7V / 200lm

Switch: Press ON/OFF / Stepless dimmable 5%-100% / Colour temperature 2700K&3000K / Memory function

Battery: Li-ion battery / 4400mAh / Charge time≤6hours / Working time≥9hours(100% light intensity)

Adapter(Optional): CLASSII / Input AC100-240V / Output DC5V1A

Multi contact charging shelf(optional): Stackable up to 3 levels. One charger shelf charges 6 table lamps together.

Others: Safety ClassIII / IP65

FINISH AVAILABLE

- | | | | | | | | |
|------------|--|------------|--|-----------------|--|-------------|--|
| Dark Grey | | Matt White | | Terracotta | | Cobalt Blue | |
| Matt Black | | Corten | | Matt Green Grey | | Matt Sand | |

CONTACT CHARGING



Item No.: A0208

Description: Table lamp round shape single charger (contact charging base).





TABLE LAMPS

Item No.: F1734-270-CC

DEMI



TECHNICAL INFORMATION

LEDs: OSRAM SMD2835 / CRI≥80 / 2W / DC3.7V / 120lm

Switch: Press ON/OFF / Stepless dimmable 5%-100% / Colour temperature 2200K&3000K / Memory function

Battery: Li-ion battery / 3000mAh / Charge time≤4.5hours / Working time≥15hours(100% light intensity)

Adapter(Optional): CLASSII / Input AC100-240V / Output DC5V1A

Multi contact charging shelf(optional): Stackable up to 3 levels. One charger shelf charges 6 table lamps together.

Others: Safety ClassIII / IP65

FINISH AVAILABLE



CONTACT CHARGING



Item No.: A0208

Description: Table lamp round shape single charger (contact charging base).





TABLE LAMPS

Item No.: F1641-280-CC

DECO



TECHNICAL INFORMATION

LEDs: OSRAM SMD2835 / CRI≥80 / 2.0W / DC3.7V

Switch: Touch ON/OFF / Stepless dimmable 5%-100% / Colour temperature 2200K&2700K / Memory function

Battery: Li-ion battery / 4400mAh / Charge time≤6.5hours / Working time≥9hours(100% light intensity)

Adapter(Optional): CLASSII / Input AC100-240V / Output DC5V1A

Multi contact charging shelf(optional): Stackable up to 3 levels. One charger shelf charges 6 table lamps together.

Others: Safety ClassIII / IP65

FINISH AVAILABLE

- | | | | | | | | |
|------------|---|------------|---|-----------------|---|--------|---|
| Dark Grey | ■ | Matt White | ■ | Orange | ■ | Blue | ■ |
| Matt Black | ■ | Corten | ■ | Matt Green Grey | ■ | Yellow | ■ |

CONTACT CHARGING



Item No.: A0208

Description: Table lamp round shape single charger (contact charging base).

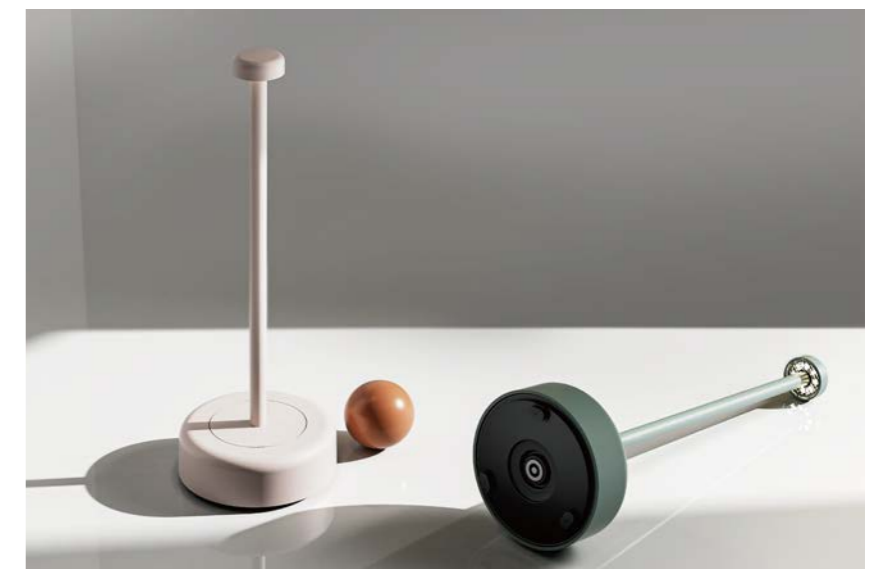

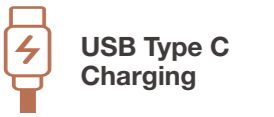
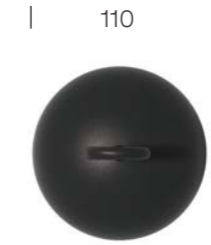

Table Lamp & Hanging Lamp



Made For Life

HOOK



TECHNICAL INFORMATION

LEDs: OSRAM SMD2835 / CRI≥80 / 2.5W / DC3.7V / 210lm

Switch: Touch ON/OFF / Stepless dimmable 5%-100% / Colour temperature 2700K&3000K / Memory function

Battery: Li-ion battery / 4400mAh / Charge time≤6hours / Working time≥11hours(100% light intensity)

Adapter(Optional): CLASSII / Input AC100-240V / Output DC5V1A

USB Type C charging cable included: 1.5m USB cable

Others: Safety ClassIII / IP65 / Weight 750g

FINISH AVAILABLE

- Dark Grey
- Matt White
- Orange
- Blue
- Matt Black
- Corten
- Matt Green Grey
- Yellow

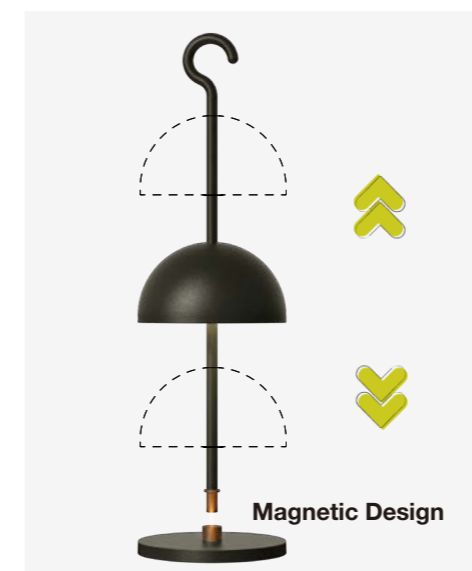

Magnetic Design



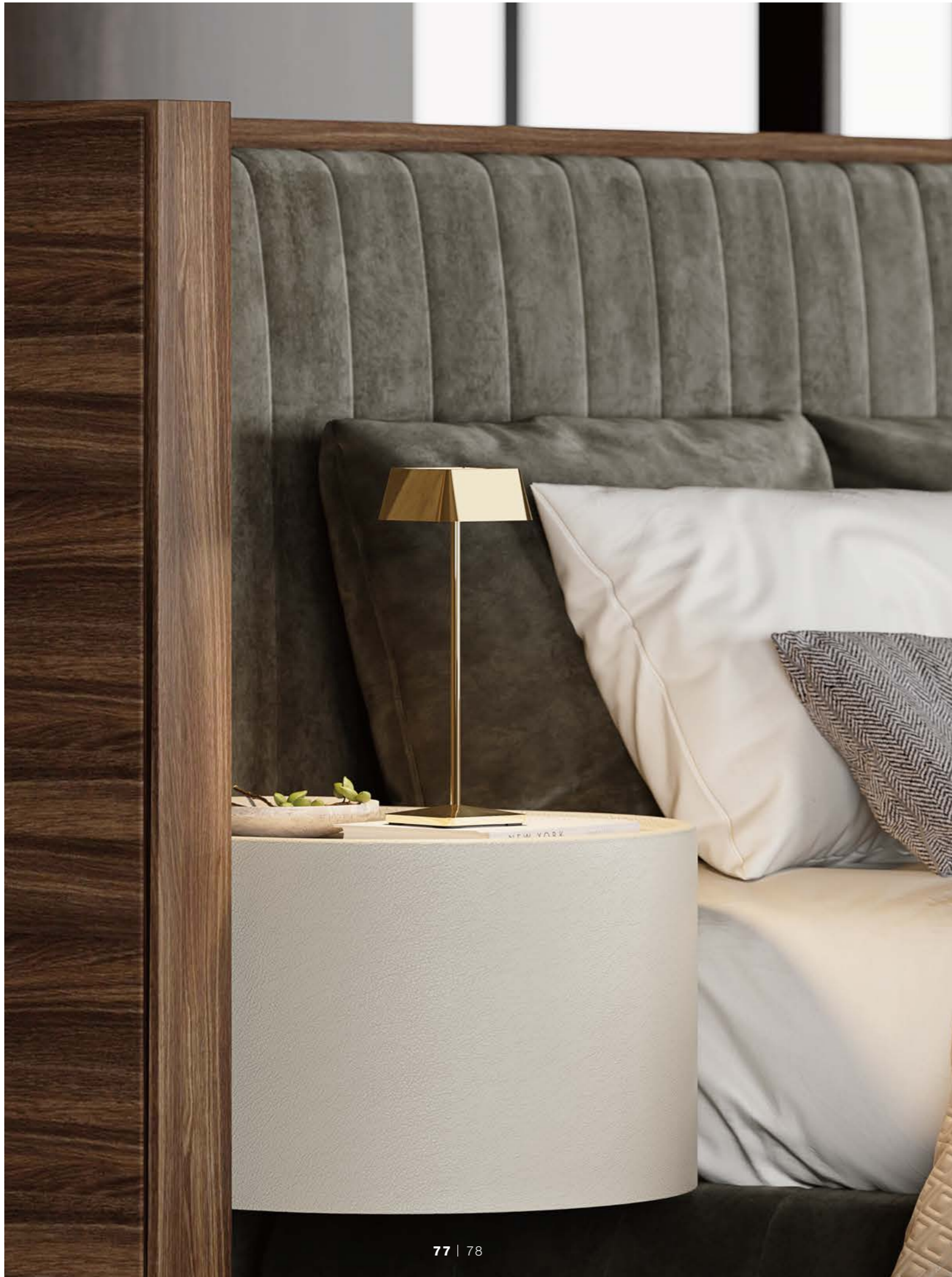

JUPITER



TECHNICAL INFORMATION

LEDs: OSRAM SMD2835 / CRI≥80 / 2.5W / DC3.7V / 181lm

Switch: Touch ON/OFF / Stepless dimmable 5%-100% / Colour temperature 2200K&2700K / Memory function

Battery: Li-ion battery / 4400mAh / Charge time≤6.5hours / Working time≥9hours(100% light intensity)

Adapter(Optional): CLASSII / Input AC100-240V / Output DC5V 1A

Micro multi contact charging shelf(optional): Stackable up to 3 levels. One charger shelf charges 6 table lamps together.

Others: Safety ClassIII / IP65 / Weight 709g

FINISH AVAILABLE

- | | | | | | | | |
|---------------|--|-------------|--|-----------------|--|-------------------|--|
| Dark Grey | | Matt White | | Terracotta | | Cobalt Blue | |
| Matt Black | | Corten | | Matt Green Grey | | Matt Sand | |
| Lustre Chrome | | Lustre Gold | | Lustre Copper | | Lustre Space Grey | |

CONTACT CHARGING



Item No.: A0208

Description: Table lamp round shape single charger (contact charging base).





TABLE LAMPS

Item No.: F1861-300-CC

SATURN



TECHNICAL INFORMATION

LEDs: OSRAM SMD2835 / CRI≥80 / 2.5W / DC3.7V / 179lm

Switch: Touch ON/OFF / Stepless dimmable 5%-100% / Colour temperature 2200K&2700K / Memory function

Battery: Li-ion battery / 4400mAh / Charge time≤6.5hours / Working time≥9hours(100% light intensity)

Adapter(Optional): CLASSII / Input AC100-240V / Output DC5V1A

Micro multi contact charging shelf(optional): Stackable up to 3 levels. One charger shelf charges 6 table lamps together.

Others: Safety ClassIII / IP65 / Weight 697g

FINISH AVAILABLE

- | | | | | | | | |
|---------------|--|-------------|--|-----------------|--|-------------------|--|
| Dark Grey | | Matt White | | Terracotta | | Cobalt Blue | |
| Matt Black | | Corten | | Matt Green Grey | | Matt Sand | |
| Lustre Chrome | | Lustre Gold | | Lustre Copper | | Lustre Space Grey | |

CONTACT CHARGING



Item No.: A0208

Description: Table lamp round shape single charger (contact charging base).



MERCURY

Mercury has a micro size, simple and unique appearance, and powerful functions, providing more diverse choices for work and life.



MERCURY



TECHNICAL INFORMATION

LEDs: OSRAM SMD2835 / CRI≥80 / 2.3W / DC3.7V / 180lm

Switch: Touch ON/OFF / Stepless dimmable 5%-100% / Colour temperature 2200K&2700K / Memory function

Battery: Li-ion battery / 3000mAh / Charge time≤4.5hours / Working time≥8hours(100% light intensity)

Adapter(Optional): CLASSII / Input AC100-240V / Output DC5V1A

Micro multi contact charging shelf(optional): Stackable up to 3 levels. One charger shelf charges 15 table lamps together.

Others: Safety ClassIII / IP65 / Weight 250g

FINISH AVAILABLE

- | | | | | | | | |
|---------------|--|-------------|--|-----------------|--|-------------------|--|
| Dark Grey | | Matt White | | Terracotta | | Cobalt Blue | |
| Matt Black | | Corten | | Matt Green Grey | | Matt Sand | |
| Lustre Chrome | | Lustre Gold | | Lustre Copper | | Lustre Space Grey | |

CONTACT CHARGING



Item No.: A0208

Description: Table lamp round shape single charger (contact charging base).





TABLE LAMPS

Item No.: F1731S-250-CC

PLUTO

| 47 |



250

TECHNICAL INFORMATION

LEDs: OSRAM SMD2835 / CRI≥80 / 2.3W / DC3.7V / 170lm

Switch: Touch ON/OFF / Stepless dimmable 5%-100% / Colour temperature 2200K&2700K / Memory function

Battery: Li-ion battery / 3000mAh / Charge time≤4.5hours / Working time≥8hours(100% light intensity)

Adapter(Optional): CLASSII / Input AC100-240V / Output DC5V1A

Micro multi contact charging shelf(optional): Stackable up to 3 levels. One charger shelf charges 15 table lamps together.

Others: Safety ClassIII / IP65 / Weight 320g

FINISH AVAILABLE

- | | | | | | | | |
|---------------|--|-------------|--|-----------------|--|-------------------|--|
| Dark Grey | | Matt White | | Terracotta | | Cobalt Blue | |
| Matt Black | | Corten | | Matt Green Grey | | Matt Sand | |
| Lustre Chrome | | Lustre Gold | | Lustre Copper | | Lustre Space Grey | |

CONTACT CHARGING



Item No.: A0208

Description: Table lamp round shape single charger (contact charging base).



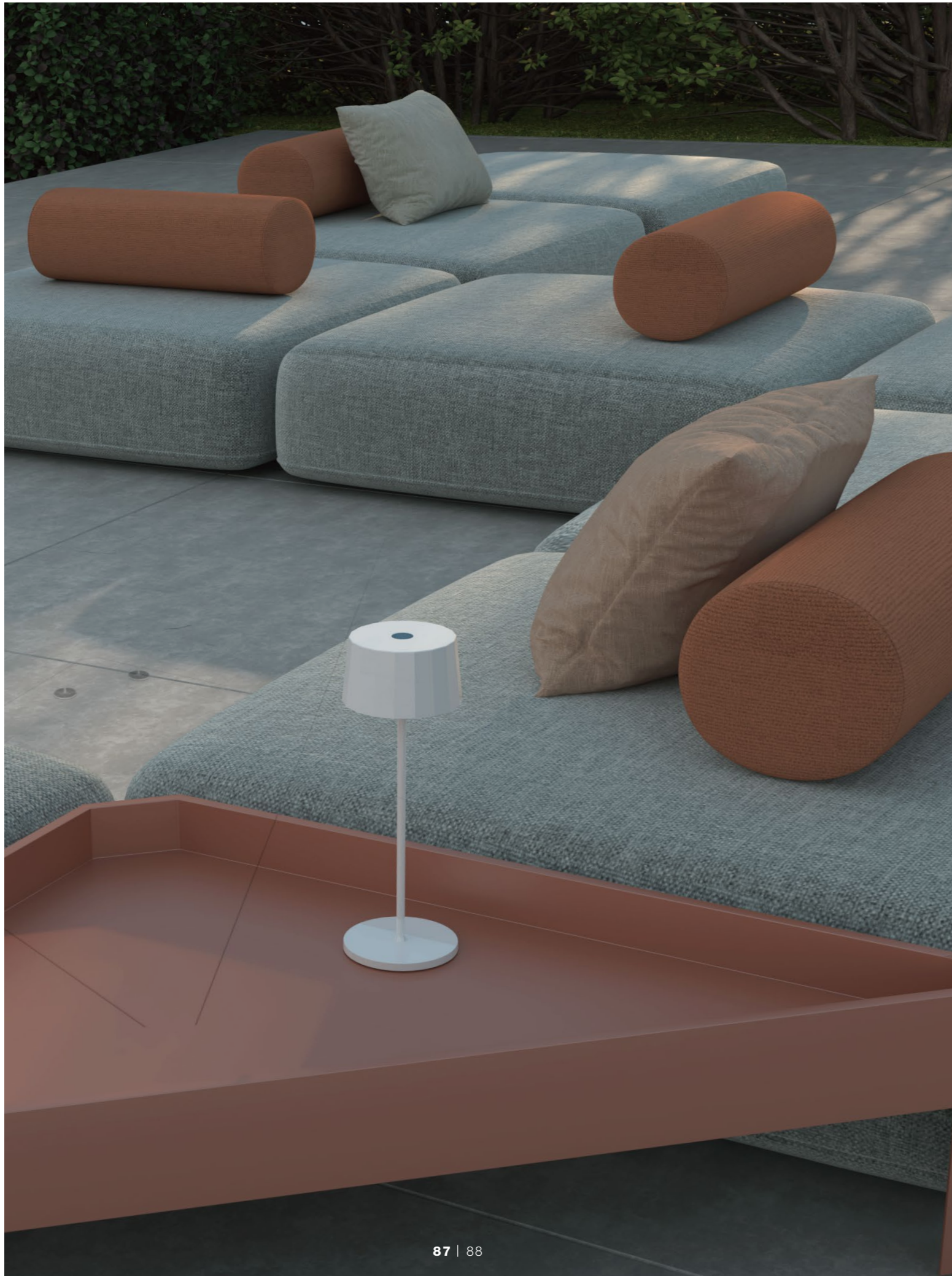

TABLE LAMPS

Item No.: F1001-360A-CC

FOLDS



TECHNICAL INFORMATION

LEDS: OSRAM LED Module / CRI≥80 / 2.2W / DC3.7V / 150lm

Switch: Touch ON/OFF / Stepless dimmable 5%-100% / Colour temperature 2700K&3000K / Memory function

Battery: Li-ion battery / 4400mAh / Charge time≤6hours / Working time≥8hours(100% light intensity)

Adapter(Optional): CLASSII / Input AC100-240V / Output DC5V1A

Multi contact charging shelf(optional): Stackable up to 3 levels. One charger shelf charges 6 table lamps together.

Others: Safety ClassIII / IP65

FINISH AVAILABLE

- | | | | | | | | |
|------------|--|------------|--|-----------------|--|--------|--|
| Dark Grey | | Matt White | | Orange | | Blue | |
| Matt Black | | Corten | | Matt Green Grey | | Yellow | |

CONTACT CHARGING



Item No.: A0203

Description: Table lamp round shape single charger (contact charging base).





TABLE LAMPS

Item No.: F1002-360A-CC

BLOW



TECHNICAL INFORMATION

LEDS: OSRAM LED Module / CRI≥80 / 2.2W / DC3.7V / 150lm

Switch: Touch ON/OFF / Stepless dimmable 5%-100% / Colour temperature 2700K&3000K / Memory function

Battery: Li-ion battery / 4400mAh / Charge time≤6hours / Working time≥8hours(100% light intensity)

Adapter(Optional): CLASSII / Input AC100-240V / Output DC5V1A

Multi contact charging shelf(optional): Stackable up to 3 levels. One charger shelf charges 6 table lamps together.

Others: Safety ClassIII / IP65

FINISH AVAILABLE

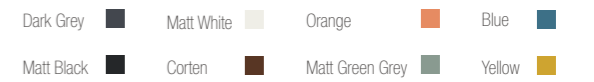

CONTACT CHARGING



Item No.: A0203

Description: Table lamp round shape single charger (contact charging base).





TABLE LAMPS

Item No.: F1003-200D-CC
F1003-360D-CC

DREAM



TECHNICAL INFORMATION

LEDS: OSRAM LED Module / CRI≥80 / 2.2W / DC3.7V / 150lm

Switch: Touch ON/OFF / Stepless dimmable 5%-100% / Colour temperature 2700K&3000K / Memory function

Battery: Li-ion battery / 4400mAh / Charge time≤6hours / Working time≥8hours(100% light intensity)

Adapter(Optional): CLASSII / Input AC100-240V / Output DC5V1A

Multi contact charging shelf(optional): Stackable up to 3 levels. One charger shelf charges 6 table lamps together.

Others: Safety ClassIII / IP65

FINISH AVAILABLE

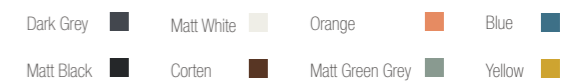

CONTACT CHARGING



Item No.: A0203

Description: Table lamp round shape single charger (contact charging base).

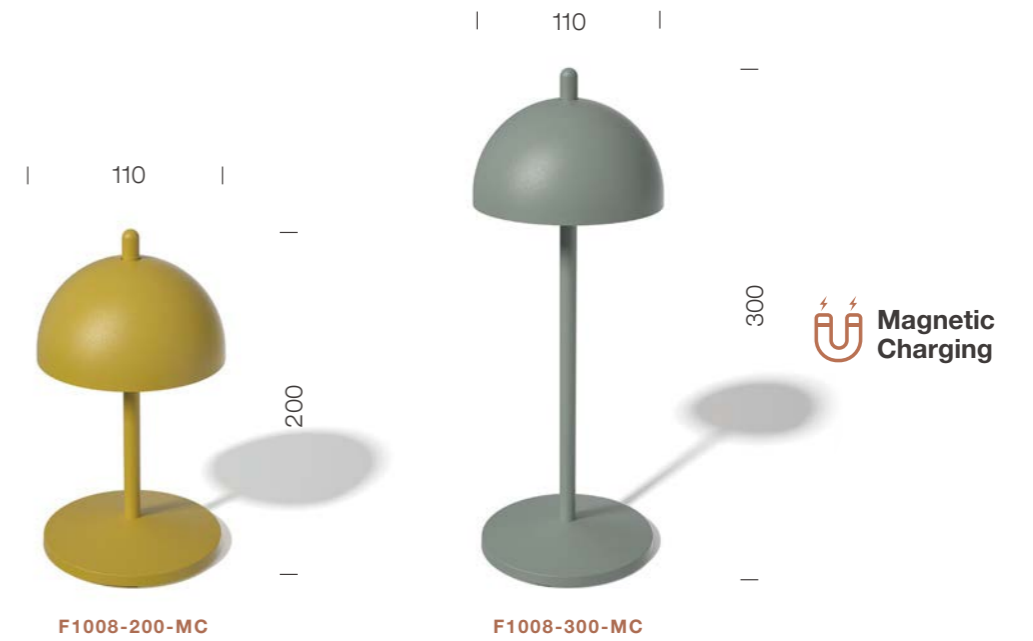



TABLE LAMPS

Item No.: F1008-200-MC
F1008-300-MC

BELL



TECHNICAL INFORMATION

LEDs: OSRAM SMD / CRI≥80 / 3.5W / DC3.7V / 205lm

Switch: Press ON/OFF / Stepless dimmable 5%-100% / Colour temperature 2700K - 4000K / Memory function

Battery: Li-ion battery / 4400mAh / Charge time≤6.5hours / Working time≥11hours(100% light intensity)

Adapter(Optional): CLASSII / Input AC100-240V / Output DC5V1A

Multi contact charging shelf(optional): Stackable up to 3 levels. One charger shelf charges 6 table lamps together.

Others: Safety ClassIII / IP65

FINISH AVAILABLE

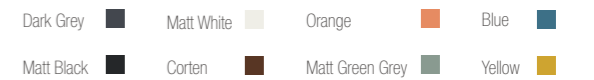

MAGNETIC CHARGING



Item No.: A0212

Magnetic contact charging system: 1.5m USB cable included.





TABLE LAMPS

Item No.: F1100-300B-CC
F1100-360B-CC

BASIC



TECHNICAL INFORMATION

LEDS: OSRAM LED Module / CRI≥80 / 2.2W / DC3.7V / 150lm

Switch: Touch ON/OFF / Stepless dimmable 5%-100% / Colour temperature 2700K&3000K / Memory function

Battery: Li-ion battery / 4400mAh / Charge time≤6hours / Working time≥8hours(100% light intensity)

Adapter(Optional): CLASSII / Input AC100-240V / Output DC5V1A

Multi contact charging shelf(optional): Stackable up to 3 levels. One charger shelf charges 6 table lamps together.

Others: Safety ClassIII / IP65

FINISH AVAILABLE

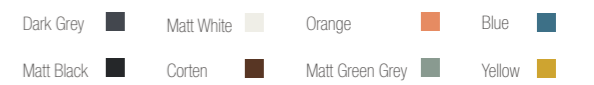

CONTACT CHARGING



Item No.: A0204

Description: Table lamp square shape single charger (contact charging base).





TABLE LAMPS

Item No.: F1103-200E-CC
F1103-360E-CC

MAYA



TECHNICAL INFORMATION

LEDS: OSRAM LED Module / CRI≥80 / 2.2W / DC3.7V / 150lm

Switch: Touch ON/OFF / Stepless dimmable 5%-100% / Colour temperature 2700K&3000K / Memory function

Battery: Li-ion battery / 4400mAh / Charge time≤6hours / Working time≥8hours(100% light intensity)

Adapter(Optional): CLASSII / Input AC100-240V / Output DC5V1A

Multi contact charging shelf(optional): Stackable up to 3 levels. One charger shelf charges 6 table lamps together.

Others: Safety ClassIII / IP65

FINISH AVAILABLE

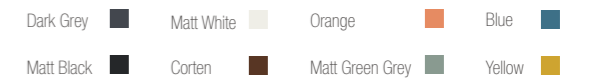

CONTACT CHARGING



Item No.: A0204

Description: Table lamp square shape single charger (contact charging base).



SERIF



TECHNICAL INFORMATION

LEDS: OSRAM SMD2835 / CRI≥80 / 2.5W / DC3.7V / 208lm

Switch: Touch ON/OFF / Stepless dimmable 5%-100% / Colour temperature 2700K&4000K / Memory function

Battery: Li-ion battery / 4400mAh / Charge time≤6hours / Working time≥10.2hours(100% light intensity)

Adapter(Optional): CLASSII / Input AC100-240V / Output DC5V1A

Others: Safety ClassIII / IP65 / Weight 900g

FINISH AVAILABLE

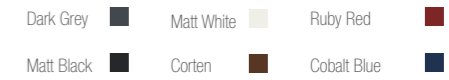

CONTACT CHARGING



Item No.: A0208

Description: Table lamp round shape single charger (contact charging base).



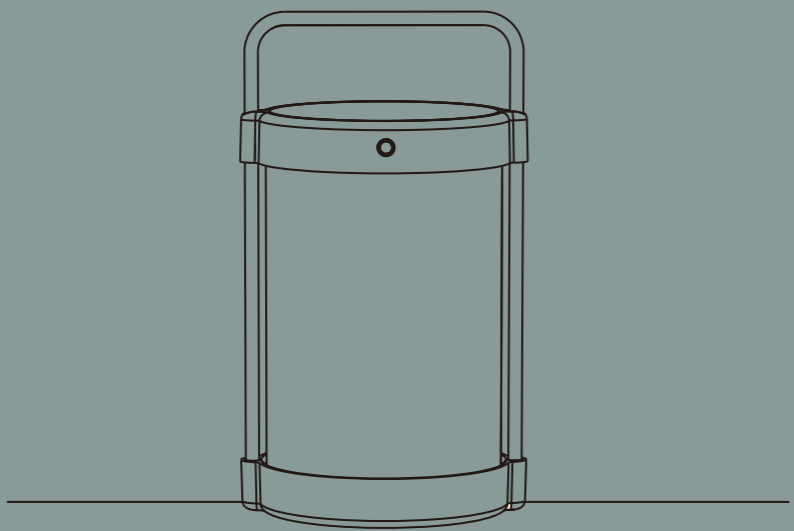

LANTERNS

Lanterns are combined with modernist architectural style and new energy solar together. The soft light shines through the clean lines, creating a cozy atmosphere at nightfall.



LANTERNS

Item No.: F1621S-MC
F1621L-MC

TERRACE

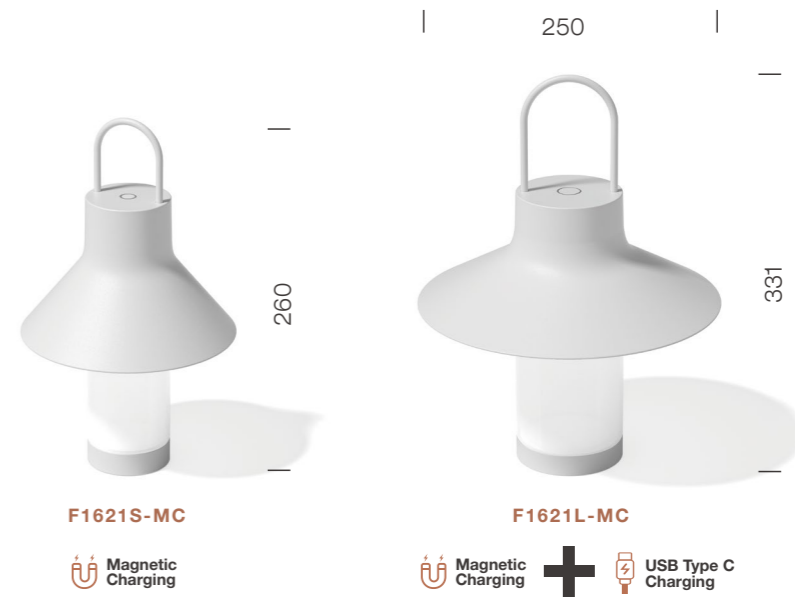

TECHNICAL INFORMATION

LEDS: OSRAM SMD 2835 / CRI≥80 / 3W / DC3.7V / 212lm
Colour temperature 2700K&3000K / Memory function

Battery: Li-ion battery / 4400mAh / Charge time≤6.5hours /
Working time≥9hours(100% light intensity)

Adapter(Optional): CLASSII / Input AC100-240V / Output DC5V1A

Others: Safety ClassIII / IP65 / Weight: 660g/1260g

FINISH AVAILABLE



MAGNETIC CHARGING



Item No.: A0204

Magnetic contact charging system: 1.5m
USB cable included.





LANTERNS

Item No.: F9030-300
F9030-450

JAR



TECHNICAL INFORMATION

LEDS: OSRAM SMD 2835 / CRI≥80 / 2.5W / DC3.7V / 210lm

Switch: Button ON/OFF / Stepless dimmable 5%-100% / Colour temperature 2700K&3000K / Memory function

Battery: Li-ion battery / 4400mAh / USB Charge times≤5.5hours / Working time≥11hours(100% light intensity) / Solar charging time:≤20 hours

Adapter(Optional): CLASSII / Input AC100-240V / Output DC5V1A

USB Type C charging cable included: 1.5m USB cable

Others: Safety ClassIII / IP65 / Weight 1590g/1690g

FINISH AVAILABLE

- | | | | | | | | |
|------------|--|------------|--|------------|--|-------------|--|
| Dark Grey | | Matt White | | Ruby Red | | Cobalt Blue | |
| Matt Black | | Corten | | Pale Green | | Matt Sand | |





LANTERNS

Item No.: F1030-300
F1030-500

TAKE ME

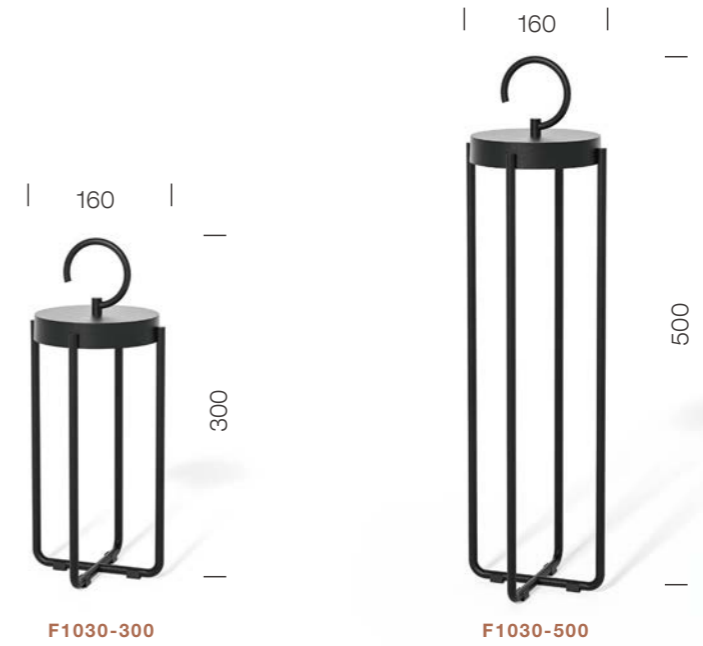

TECHNICAL INFORMATION

LEDS: OSRAM SMD 2835 / CRI≥80 / 2.5W / DC3.7V / 198lm

Switch: Touch ON/OFF / Stepless dimmable 5%-100% / Colour temperature 2700K&3000K / Memory function

Battery: Li-ion battery / 4400mAh / Charge time≤5.5hours / Working time≥8hours(100% light intensity)

Adapter(Optional): CLASSII / Input AC100-240V / Output DC5V1A

USB Type C charging cable included: 1.5m USB cable

Others: Safety ClassIII / IP65 / Weight 800g/1000g

FINISH AVAILABLE

- | | | | |
|------------|------------|------------|-------------|
| Dark Grey | Matt White | Ruby Red | Cobalt Blue |
| Matt Black | Corten | Pale Green | Matt Sand |





LANTERNS

Item No.: F1012-300B
F1012-500B

BAY

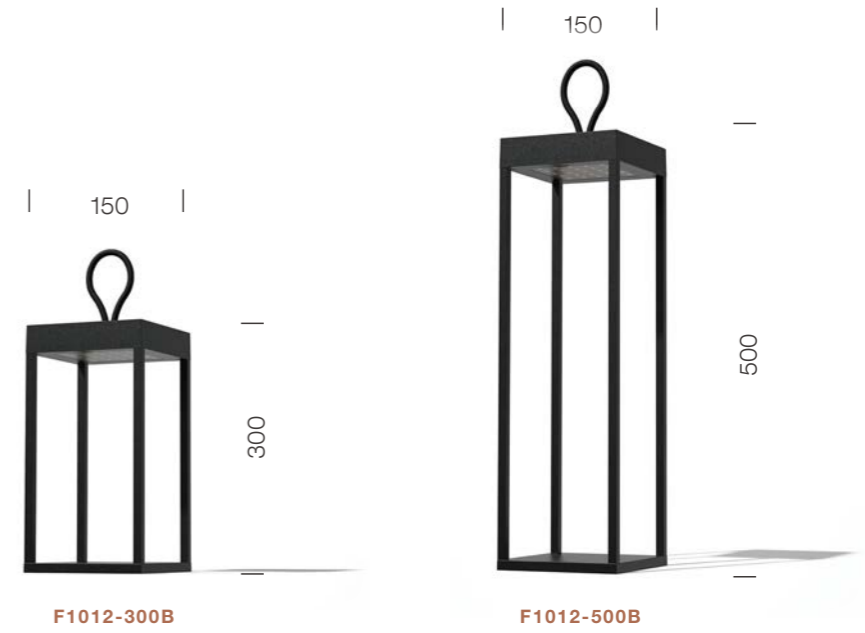

TECHNICAL INFORMATION

LEDS: SMD LED Module / CRI≥80 / 2.2W / DC3.7V / 220lm

Switch: Touch ON/OFF / Stepless dimmable 5%-100% /
Colour temperature 2700K&3000K / Memory function

Battery: Li-ion battery / 2200mAh×2 /Charge time≤6.5hours /
Working time≥11hours(100% light intensity)

Adapter(Optional): CLASSII / Input AC100-240V / Output DC5V1A

USB Type C charging cable included: 1.5m USB cable

Others: Safety ClassIII / IP65

FINISH AVAILABLE

Dark Grey ■ Matt White ■ Matt Black ■ Corten ■





LANTERNS

Item No.: F9000-300B|F9001-300B
F9000-500B|F9001-500B

SUNNY



TECHNICAL INFORMATION

LEDs: SMD LED Module / CRI≥80 / 2.2W / DC3.7V / 180lm

Switch: Button ON/OFF / Stepless dimmable 5%-100% / Colour temperature 2700K&3000K / Memory function

Battery: Li-ion battery / 2200mAh×2 / USB Charge time≤6.5hours / Working time≥11hours(100% light intensity) / Solar charging time:<20 hours

Adapter(Optional): CLASSII / Input AC100-240V / Output DC5V1A

USB Type C charging cable included: 1.5m USB cable

Others: Safety ClassIII / IP65 / Weight 1590g/1690g

FINISH AVAILABLE

Dark Grey ■ Matt White ■ Matt Black ■ Corten ■

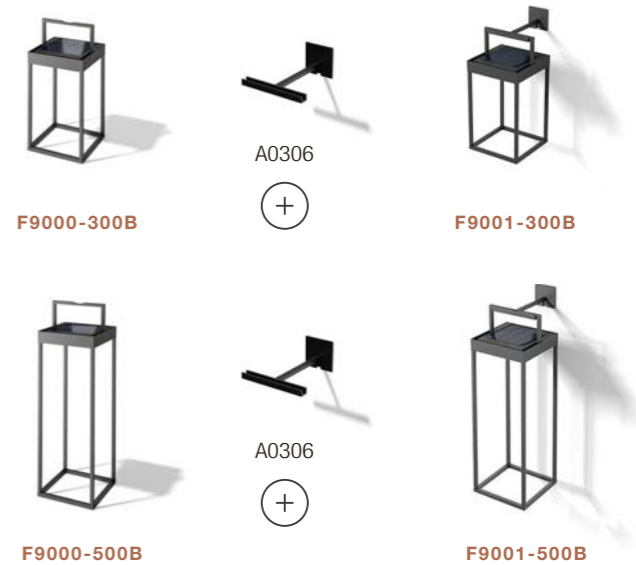



LANTERNS

Item No.: E1230-380-CC

CHARM

150

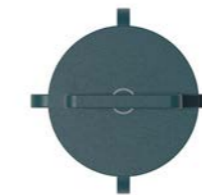

438



TECHNICAL INFORMATION

LEDs: OSRAM SMD / CRI≥80 / 2.5W / DC3.7V / 519lm

Switch: Touch ON/OFF / Stepless dimmable 5%-100% / Colour temperature 2700K&3000K / Memory function

Battery: Li-ion battery / 2200mAh×2 / Charge time≤7hours / Working time≥11hours(100% light intensity)

Adapter(Optional): CLASSII / Input AC100-240V / Output DC5V1A

Single contact charging base incl-: 1.5m USB cable

Others: Safety ClassIII / IP65 / Weight 1860g

FINISH AVAILABLE

- Dark Grey
- Matt White
- Matt Black
- Corten
- Ocean Blue
- Terracotta

CONTACT CHARGING

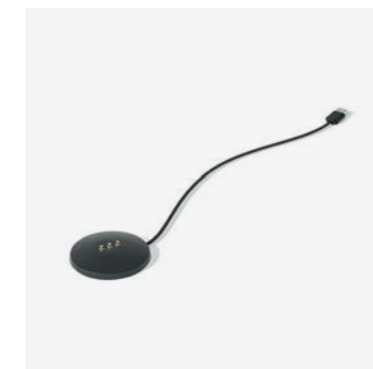

Item No.: A0205

Description: Round shape single charger (contact charging base).



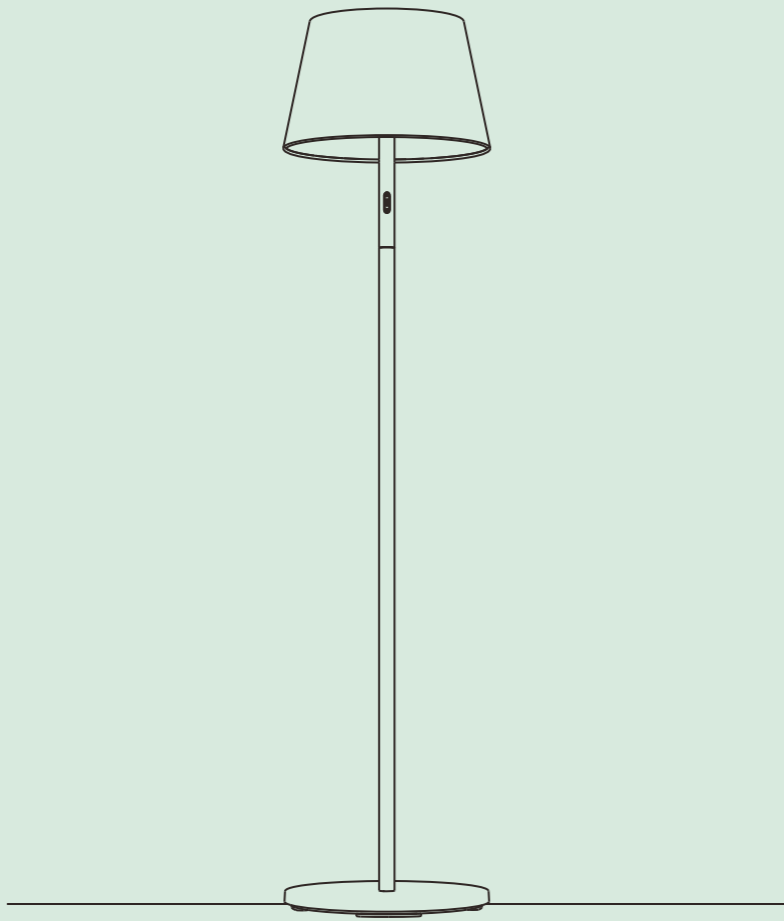

FLOOR LAMPS

Floor lamps combine intelligent innovation with the highest standards of design. Inspired by the feeling of evening breeze, think about human sustainability, then combine with modernist architecture style and new technology.

APOLLO

TECHNICAL INFORMATION

LEDS: OSRAM SMD2835 / CRI≥80 / 10W / DC3.7V / 810lm

Switch: Press ON/OFF / Stepless dimmable 5%-100% /
 Colour temperature: 2700K, 3000K & 4000K (switchable) /
 RGB: Red, orange, yellow, green, blue, indigo & violet (switchable) /
 Memory function: Memory of brightness, colour temperature and RGB

Battery: Li-ion battery / 13200mAh / Charge time≤7hours /
 Working time≥11hours(100% light intensity)

Adapter(Optional): CLASSII / Input AC100-240V / Output DC5V3A

Others: Safety ClassIII / IP65 / Weight 9400g

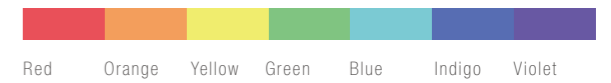

Red Orange Yellow Green Blue Indigo Violet

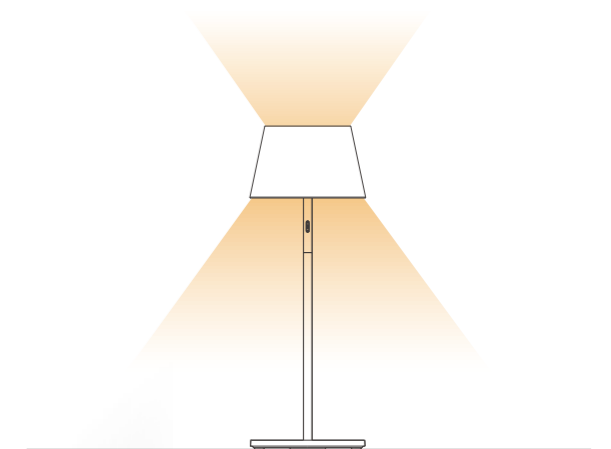
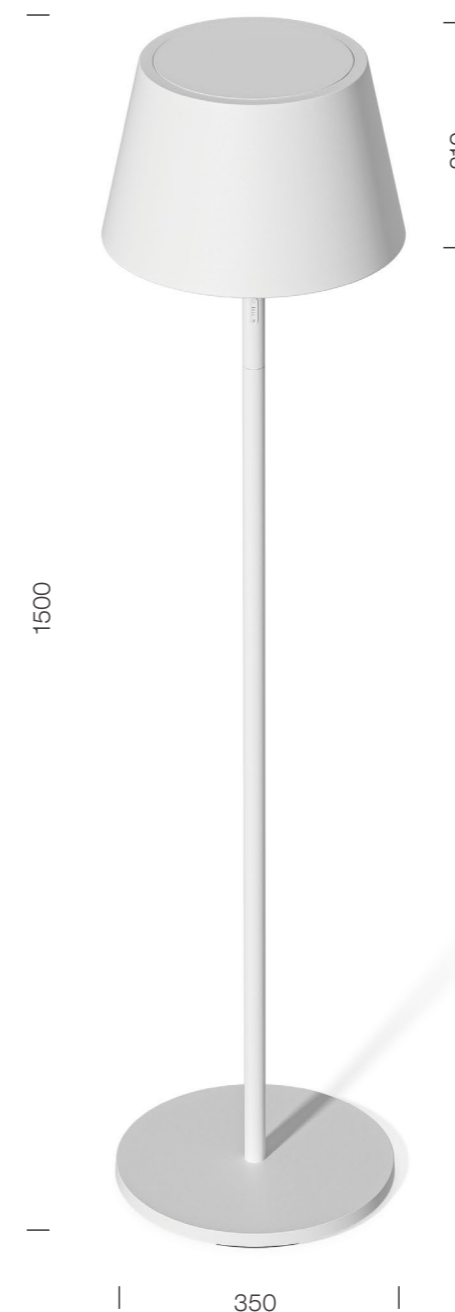

FINISH AVAILABLE

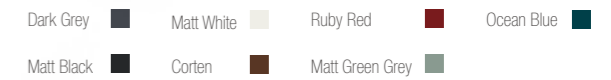

CONTACT CHARGING



Item No.: A0207

Description: Floor lamp round shape single charger (contact charging base).



Item No.: A0209

Description: USB Adapter, CLASS II, Input AC100-240V, Output DC5V 3A.





Three Detachable Lamp Poles

The pole consists of three detachable poles which are not only easy to pack and transport, but also allow you to choose the height of the light to suit your needs.



Weather & Atmospheric Resistant Finish

Waterproof IP65

- ON/OFF & Dimmer Switch
- Battery Indicator
- CCT & RGB Switch

Double Switch & Battery Indicator

ON/OFF & dimmer switch, CCT & RGB switch. Memory of brightness, colour temperature & RGB.

The battery indicator will tell you when you need to charge, so that it doesn't affect your experience.

Simple Appearance

The appearance keeps simple geometry to bring clean and harmonious feeling. The design gives a reliable in & outdoor lighting tool.



FLOOR LAMPS

Item No.: F2002-1500A-CC

SOLO

TECHNICAL INFORMATION

LEDS: OSRAM SMD2835 / CRI≥80 / 10W / DC3.7V / 810lm

Switch: Press ON/OFF / Stepless dimmable 5%-100% / Colour temperature 2700K&3000K / Memory function

Battery: Li-ion battery / 13200mAh / Charge time≤7hours / Working time≥11hours(100% light intensity)

Adapter(Optional): CLASSII / Input AC100-240V / Output DC5V3A

Others: Safety ClassIII / IP65 / Weight 9400g

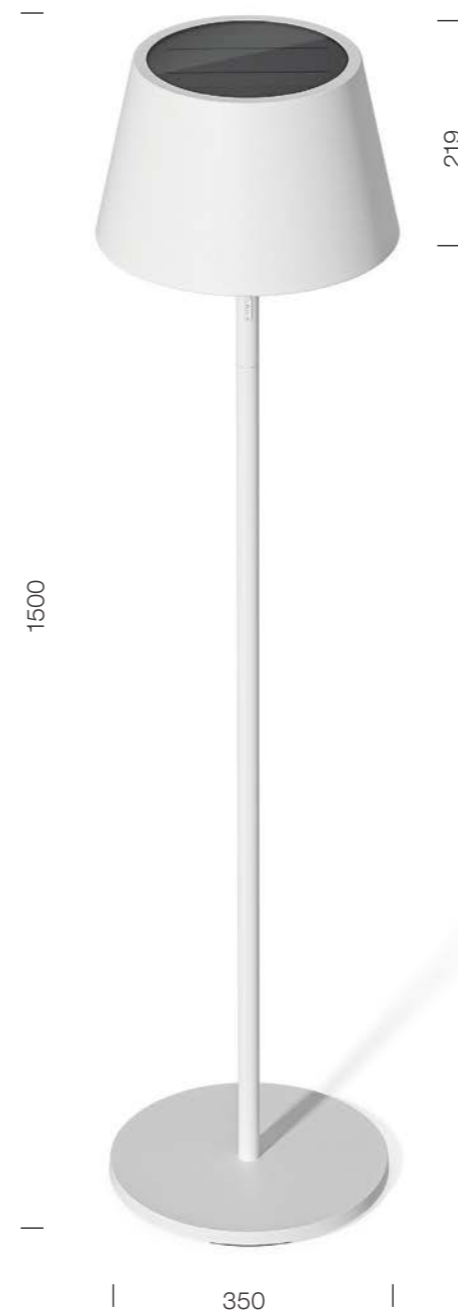

FINISH AVAILABLE

- | | | | | | | | |
|------------|--|------------|--|-----------------|--|------------|--|
| Dark Grey | | Matt White | | Ruby Red | | Ocean Blue | |
| Matt Black | | Corten | | Matt Green Grey | | | |

CONTACT CHARGING



Item No.: A0207

Description: Floor lamp round shape single charger (contact charging base).



Item No.: A0209

Description: USB Adapter, CLASS II, Input AC100-240V, Output DC5V 3A.

DREAM FLOOR

TECHNICAL INFORMATION

LEDs: OSRAM SMD2835 / CRI≥80 / 2.2W / DC3.7V / 258lm









Switch: Touch ON/OFF / Stepless dimmable 5%-100% / Colour temperature 2700K&3000K / Memory function

Battery: Li-ion battery / 4400mAh / Charge time≤6.3hours / Working time≥8hours(100% light intensity)

Adapter(Optional): CLASSII / Input AC100-240V / Output DC5V1A

Others: Safety ClassIII / IP65 / Weight 1470g

FINISH AVAILABLE

Dark Grey		Matt White		Terracotta		Cobalt Blue	
Matt Black		Corten		Matt Green Grey		Matt Sand	



CONTACT CHARGING



Item No.: A0207

Description: Floor lamp round shape single charger (contact charging base).



1090

159



ELF FLOOR

TECHNICAL INFORMATION

LEDs: OSRAM SMD2835 / CRI≥80 / 2.5W / DC3.7V / 170lm









Switch: Touch ON/OFF / Stepless dimmable 5%-100% / Colour temperature 2700K&3000K / Memory function

Battery: Li-ion battery / 4400mAh / Charge time≤8hours / Working time≥10hours(100% light intensity)

Adapter(Optional): CLASSII / Input AC100-240V / Output DC5V1A

Others: Safety ClassIII / IP65 / Weight 2300g

FINISH AVAILABLE

- | | | | | | | | |
|------------|---|------------|---|-----------------|---|-------------|---|
| Dark Grey |  | Matt White |  | Terracotta |  | Cobalt Blue |  |
| Matt Black |  | Corten |  | Matt Green Grey |  | Matt Sand |  |



MAGNETIC CHARGING



Item No.: A02012

Magnetic contact charging system: 1.5m USB cable included.



1200

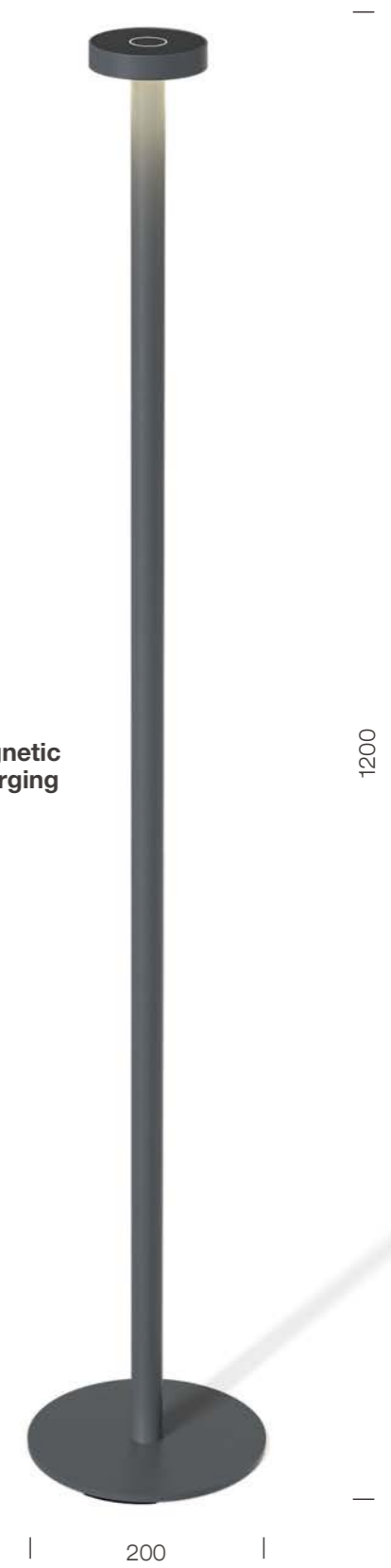

200



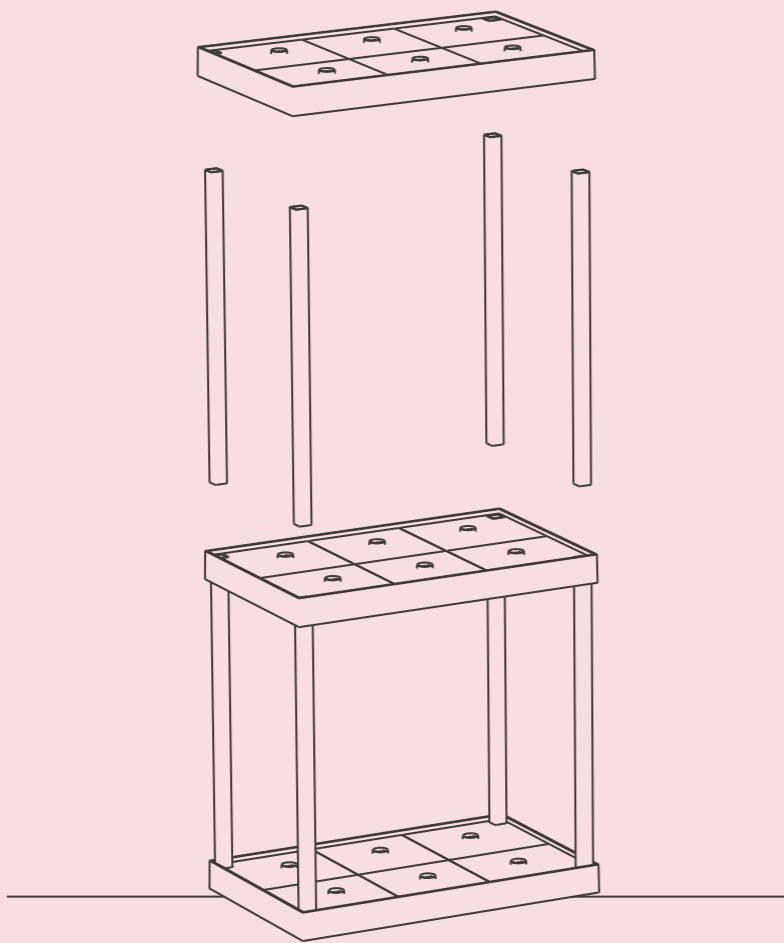

ACCESSORIES

Accessories include various charging shelves to provide convenient charging options for HeReCa and give customers more freedom to give the product different applications.



6 Multiple Contact Charging Shelf

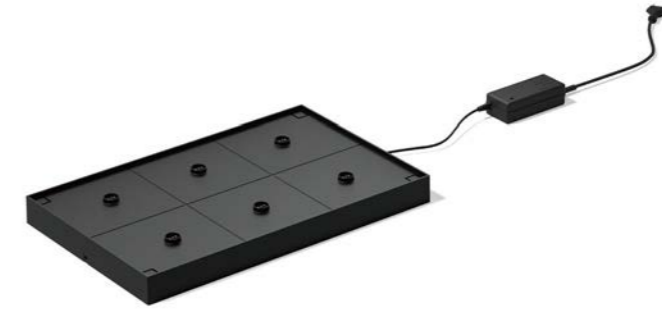

Item No.: A0201

Recharging and storage multi-contact charging shelf. Stackable up to 3 levels. One charger shelf charges 6 table lamps together.



6 Multiple Magnetic Contact Charging Shelf

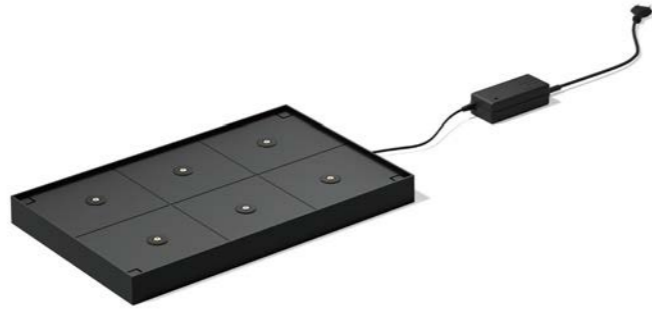

Item No.: A0214

Multi magnetic contact charging shelf. Stackable up to 3 levels. One charger shelf charges 6 table lamps together.



Micro 15 Multiple Contact Charging Shelf

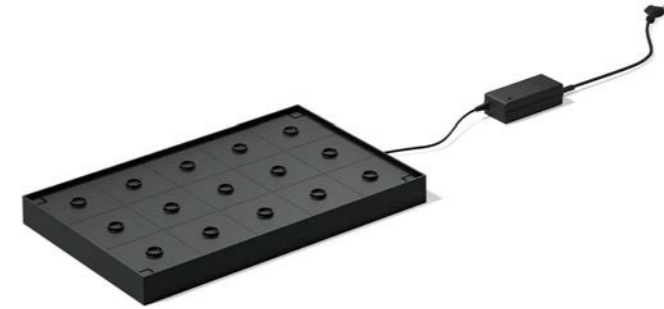

Item No.: A0217

Micro multi contact charging shelf. Stackable up to 3 levels. One charger shelf charges 15 table lamps together.



Ideal for HoReCa



Trolley



Item No.: A0218

Trolley which can carry contact charging shelf, magnetic charging shelf. One trolley carries 6 charging shelves.

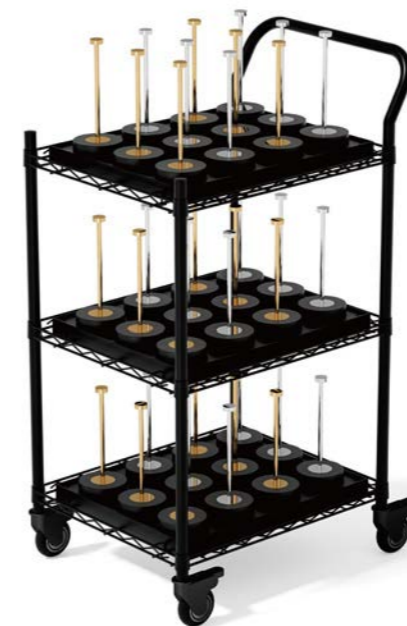

UCOME CORDLESS

Original design cordless lighting +



Tony Jiang

UCOME COO